

AGCO®

Weights and Tire Chains

Reference Guide

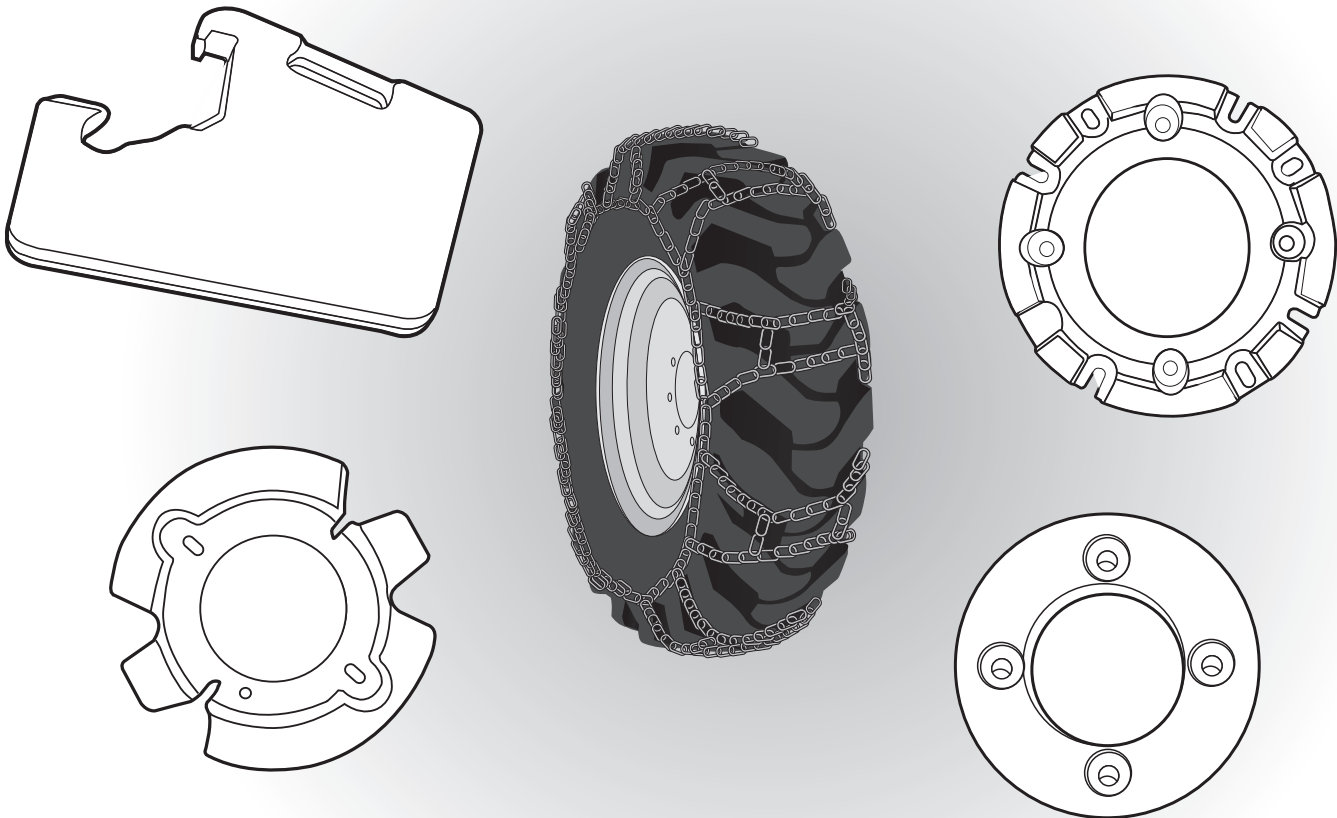

• FRONT END WEIGHTS • WHEEL WEIGHTS • TIRE CHAINS •



Promo 201



AGCO Direct Ship Weights Catalog

Weight Application Charts

AGCO	Pg. 2 – 5
ASV	Pg. 6
Bobcat	Pg. 6
Branson	Pg. 7 – 8
Case	Pg. 9 – 12
Caterpillar	Pg. 12
Challenger	Pg. 13 – 14
Cub Cadet	Pg. 15 – 17
Gehl	Pg. 18
John Deere	Pg. 19 – 25
Kioti	Pg. 26 – 27
Kubota	Pg. 28 – 32
Mahindra	Pg. 33 – 34
Massey Ferguson	Pg. 35 – 39
McCormick	Pg. 40
New Holland	Pg. 41 – 48
Grill Guards	Pg. 49
Fluid Guide	Pg. 50
Weight & Bracket Pictures	Pg. 51 – 71
Tire Chains	
Lawn & Garden	Pg. 72
Farm Tractor Fit Chart	Pg. 73
Farm Tractor – Ladder Style	Pg. 74
Farm Tractor – DUO Style	Pg. 75
Farm Tractor – Double Ring	Pg. 76
Industrial & Skid Steer	Pg. 77

AGCO

(Current Production Tractors)

Front End Weights and Brackets

Tractor Model	Bracket Part No.	Lbs. Each	Weight Part No.	Lbs. Each	Max. Weights per bkt.
ST22A	79026657	24	79018781	41	6
			79018782	70	6
ST24A - ST33A	79026657	24	79018781	41	6
			79018782	70	6
ST34A - ST60A	79023233	25	79018781	41	6
			79018782	70	6
GT45A - GT75A	79026654	44	79018801	79	10
			79018802	96	10
LT75 & LT90	Standard Equip.	-----	79018766 (76710290)	62	12
			79018767 (76710300)	87	12
RT100A - RT155A	Standard Equip.	-----	79018766 (76710290)	62	12 / 15
			79018767 (76710300)	87	12 / 15
			79023005 (72509740)	123	12 / 15
DT180A - DT240A	Standard Equip.	-----	79018767 (76710300)	87	15
			79023005 (72509740)	123	15

Wheel Weights

Tractor Model	Wheel Size	Hole Pattern	AGCO Part No.	Lbs. per Weight	Inside/Outside	Comments
ST22A - ST60A	12" Turf	4 @ 6 1/8"	79018800**	70	O	
	15" Turf	None	----	----	----	
	16.5" Turf	4 @ 6 1/8"	79018800**	70	O	
	20" Turf	3 @ 11 3/4"	79018829	75	O	Stacks
	12" & 16" Ag.	4 @ 6 1/8"	79018800**	70	O	
	18" Ag	4 @ 7 1/2"	79018826	66	I/O	Stacks
	24" Ag.	4 @ 9 1/2"	79018831	107	I/O	Stacks
		4 @ 11 1/2"	79018831	107	I/O	Stacks
	26" Ag.	4 @ 9 1/2"	79018831	107	I/O	Stacks
	28" Ag	4 @ 11 1/2"	79018831	107	I/O	Stacks
			79018838	146	O	Stacks
	16.5" Ind.	4 @ 6 1/8"	79018800**	70	O	
	18" Ind.	4 @ 7 1/2"	79018826	66	I/O	Stacks
	19.5" Ind.	None	N/A	----	----	
24" Ind.	4 @ 9 1/2"	79018831	107	I/O	Stacks	
GT45A - GT75A	28" & 30" Ag.	4 @ 11"	79018831	107	I/O	Stacks
			79018838	146	O	Stacks
LT75A & LT90A	30" - 38" Steel	3 @ 14"	79018833	108	I/O	Stacks
RT100A - T155A	34" - 50" Steel	3 @ 14"	79018833	108	I/O	Stacks - Flange axle - man. Adj.
		4 @ 12 3/4"	79018834	125	O	Stacks - Flange axle - fixed
		None	----	----	----	
	38" - 50" Cast	4 @ 12 3/4"	79018839	148	O	Stacks
		3 @ 17 1/2"	N/A	----	I	
DT180A - DT240A	38" - 54" Steel	4 @ 12 3/4"	79018834	125	O	Stacks
		None	----	----	----	
	38" - 54" Cast	4 @ 12 3/4"	79018839	148	O	Stacks
		3 @ 17 1/2"	N/A	----	I	

** Order attaching hardware separately - part number 79018850

AGCO

(Non-Current Production Tractors)

Front End Weights and Brackets

Tractor Model	Bracket No.	Lbs. Each	Weight No.	Lbs. Each	Max. Weights per bkt.
ST25 - ST33	79026657	24	79018781	41	6
			79018782	70	6
ST34 - ST55	79023233	25	79018781	41	6
			79018782	70	6
GT 45 - GT75	79026654	44	79018801	79	6
			79018802	96	6
LT70	Standard Equip.	-----	79018766	62	12
			79018767	87	12
			79023005	123	12
RT95	Standard Equip.	-----	79018766	62	12
			79018767	87	12
			79023005	123	12
DT160 - DT225	Standard Equip.	-----	79018766	62	15
			79018767	87	15
			79023005	123	15

Wheel Weights

Tractor Model	Wheel Size	Hole Pattern	Part No.	Lbs. per Weight	Inside/Outside	Comments
ST25 - ST55	16" Front	4 @ 7 1/2"	79018840	45	I	2 wd. - 4 pc. set
			79018826	66	O	Stacks
	15" & 16" Turf	None	-----	-----	-----	
			16" Ag.	3 @ 9 1/4"	79023243	80
	16.5" & 19.5" Ind.	None	-----	-----	-----	
			20" Turf	4 @ 9 1/2"	79018829	75
	24" Ag.	4 @ 9 1/2"	79023243	80	I/O	Stacks
			79018829	75	I/O	Stacks
	24" Ind.	None	-----	-----	-----	
			28" Ag.	4 @ 9 1/2"	79018829	75
GT45 - GT75	28" & 30"	4 @ 11"	79023243	80	I/O	Stacks
			79018838	146	O	Stacks
LT70	30" - 38" Steel	3 @ 14"	79018833	108	I/O	Stacks
RT95	30" - 38" Steel - Flange Axle	3 @ 14"	79018833	108	I/O	Stacks
	38" - 54" Steel - Bar Axle	None	-----	-----	-----	
	38" Cast	4 @ 12 3/4"	79018839	148	O	Stacks
3 @ 17 1/2"			N/A	-----	I	
DT160 - DT225	38" - 54" Steel - Bar Axle	None	-----	-----	-----	
			38" Cast	4 @ 12 3/4"	79018839	148
	3 @ 17 1/2"	N/A	-----	I		

AGCO - Allis

(Non-current Production Tractors)

Front End Weights and Brackets

Tractor Model	Bracket No.	Lbs. Each	Weight No.	Lbs. Each	Replaces Allis No.
4150 4650 & 4660 5650 - 5680 6670 - 6690 7600 8160 & 8630	N/A	-----	79018766	62	76710290
8745 - 8785 9130 & 9150 9435 & 9455 9630 - 9675 9735 - 9785	N/A	-----	79018766	62	76710290
			79018767	87	76710290
			79023005	123	
9170 & 9190 9670 - 9690	N/A	-----	79018765	98	70264161
9695	N/A	-----	N/A	-----	72509740
9815	N/A	-----	N/A	-----	72509741

Wheel Weights

Tractor Model	Wheel Size	Hole Pattern	AGCO Part No.	Lbs. per Weight	Inside/ Outside	Comments
4150 4650 & 4660 5650 - 5680 6670 - 6690 7600 8160 & 8630	13.6 x 28"	3 @ 16 1/2"	79018835	115	O	Stacks
	14.9 x 28"	4 @ 11"	79018838	146	O	Stacks
	30" - 34"	4 @ 11"	79018838	146	O	Stacks
	38"	3 @ 18 7/8"	79018844	111	O	Stacks
8745 - 8785	30" - 38" Steel	3 @ 12 3/4"	79018843	150	O*	Stacks
			79018837	300	I/O	Stacks
			79018833	108	I/O	Stacks
	38" - 46" Cast	4 @ 12 3/4"	79018839	148	O	Stacks
		3 @ 17 1/2"	N/A	-----	-----	
9130 - 9190 9435 & 9455 9630 - 9690 9635 - 9695	38" & 42"	4 @ 14 1/4"	79018768	165	I/O	Stacks
9735 - 9785	38" - 46" Cast	4 @ 12 3/4"	79018839	148	O	Stacks
		4 @ 14 1/4"	79018768	165	I/O	Stacks
9810	38" & 42"	4 @ 14 1/4"	79018768	165	I/O	Stacks

* Will Mount inside or outside on 34" & 38" wheels.

AGCO - White

(Non-current Production Tractors)

Front End Weights and Brackets

Tractor Model	Bracket No.	Lbs. Each	Weight No.	Lbs. Each	Replaces Allis No.
6045 – 6085 6090, 6105 6410 - 6810	N/A	-----	79018766	62	76710290
6124 & 6144 6125 - 6215 6175 & 6195 8310 - 8810	N/A	-----	79018767 79023005	87 123	76710290

Wheel Weights

Tractor Model	Wheel Size	Hole Pattern	Part No.	Lbs. per Weight	Inside/ Outside	Comments	
6045 – 6085 6090 6105	13.6 x 28"	3 @ 16 ½"	79018835	115	O	Stacks	
	14.9 x 28"	4 @ 11"	79018838	146	O	Stacks	
	30" – 34"	4 @ 11"	79018838	146	O	Stacks	
	38"	3 @ 18 7/8"	79018844	113	O	Stacks	
6124 & 6144 6125 - 6215	38" & 42"	4 @ 14 ¼"	79018768	165	I/O	Stacks	
6410 - 6810	30" – 38"	3 @ 12 ¾"	79018843	150	O*	Stacks	
			79018837	300	I/O	Stacks	
	Steel	3 @ 14"	79018833	108	I/O	Stacks	
		38" – 46"	4 @ 12 ¾"	79018839	148	O	Stacks
			3 @ 17 ½"	N/A	-----	-----	
Cast							
8310 - 8810	38" – 46"	4 @ 12 ¾"	79018839	148	O	Stacks	
	Cast						
	38" – 46"	4 @ 14 ¼"	79018768	165	I/O	Stacks	
	Cast						

ASV Skid Steer

Add up to 440 Lbs. of counter weight
Designed for Models: RC30 - RC100



Suitcase Weight

Part No. 79018812, 50 Lbs. Each
(Order attaching hardware separately,
part no. 79018849)



Bracket

Part No. 79023237, 40 Lbs. Each
(Holds 8 of suitcase weight no.
79018812)

Bobcat Counter Weights

Brackets

Part no. 79018771

(Consists of left and right bracket)
Holds up to 8 of 79018812 Suitcase weight
(4 per side)



Axle Weight



Part no. 79018769

19 lbs. each
(Includes mounting hardware)

Suitcase Weight



Part no. 79018812

50 lbs. Each
(Order attaching hardware
separately – Part no. 79018849)

Branson

(Current Production Tractors)

Front End Weights and Brackets

Tractor Model	Bracket No.	Lbs. Each	Weight No.	Lbs. Each	Max. Wts. / Bkt.
2910	79023233	25	79018781	41	6
			79018782	70	6
3510	79023233	25	79018781	41	6
			79018782	70	6
3820	79023233	25	79018781	41	6
			79018782	70	6
4220	79023233	25	79018781	41	6
			79018782	70	6
4720	79023233	25	79018781	41	6
			79018782	70	6
5530 & 6530	TBA	----	TBA	TBA	TBA

Wheel Weights

Tractor Model	Wheel Size	Hole Pattern	Part No.	Lbs. per Weight	Inside/ Outside	Comments
2910	12.4 x 24"	3 @ 9 7/8"	79018829	75	I/O	Ag. Tire
			79023243	80	I/O	
	41 x 14 - 20"	None	N/A	----	----	Turf Tire
	44 x 18 - 20"	None	N/A	----	----	Turf Tire
	15 x 19.5"	None	N/A	----	----	Ind. Tire
3510	12.4 x 24"	3 @ 9 7/8"	79018829	75	I/O	Ag. Tire
			79023243	80	I/O	
	41 x 14 - 20"	None	N/A	----	----	Turf Tire
	44 x 18 - 20"	None	N/A	----	----	Turf Tire
	15 x 19.5"	None	N/A	----	----	Ind. Tire
3820	12.4 x 28"	3 @ 9 7/8"	79018829	75	I/O	Ag. Tire
			79023243	80	I/O	
	44 x 18 - 20"	None	N/A	----	----	Turf Tire
	15 x 19.5	None	N/A	----	----	Ind. Tire
	4220	12.4 x 28"	3 @ 9 7/8"	79018829	75	I/O
79023243				80	I/O	
44 x 18 - 20"		None	N/A	----	----	Turf Tire
4720	12.4 x 28	3 @ 9 7/8"	79018829	75	I/O	Ag. Tire
			79023243	80	I/O	
	44 x 18 - 20"	None	N/A	----	----	Turf Tire
5530 & 6530	14.9 - 30"	3 @ 12 1/4"	79018829	75	I/O	Ag. Tire
			79023243	80	I/O	

Branson

(Non-Current Production Tractors)

Front End Weights and Brackets

Tractor Model	Bracket No.	Lbs. Each	Weight No.	Lbs. Each	Max. Wts. / Bkt.
2810	79023233 (FW40)	23	79018781	41	6
			79018782	70	6
3520	79023233 (FW40)	23	79018781	41	6
			79018782	70	6
4020	79023233 (FW40)	23	79018781	41	6
			79018782	70	6
4520	79023233 (FW40)	23	79018781	41	6
			79018782	70	6

Wheel Weights

Tractor Model	Wheel Size	Hole Pattern	Part No.	Lbs. per Weight	Inside/ Outside	Comments
2810	12.4 x 24"	3 @ 9 7/8"	79018829	75	I/O	Ag. Tire
			79023243	80	I/O	
	41 x 14 - 20"	None	N/A	----	----	Turf Tire
	44 x 18 - 20"	None	N/A	----	----	Turf Tire
	15 x 19.5"	None	N/A	----	----	Ind. Tire
3520	12.4 x 28"	3 @ 9 7/8"	79018829	75	I/O	Ag. Tire
			79023243	80	I/O	
	44 x 18 - 20"	None	N/A	----	----	Turf Tire
4020	12.4 x 28"	3 @ 9 7/8"	79018829	75	I/O	Ag. Tire
			79023243	80	I/O	
	44 x 18 - 20"	None	N/A	----	----	Turf Tire
4520	12.4 x 28	3 @ 9 7/8"	79018829	75	I/O	Ag. Tire
			79023243	80	I/O	
	44 x 18 - 20"	None	N/A	----	----	Turf Tire
	15 x 19.5	None	N/A	----	----	Ind. Tire

Case

(Current Production Tractors)

Front End Weights and Brackets

Tractor Model	Bracket No.	Lbs. Each	Weight No.	Lbs. Each	Weights per Bracket
DX18E - DX25E	79021963	18	79018812 **	49	5
			79018805 **	99	5
D25 - D45 DX21 - DX55	Standard Equip.	-----	79018812 **	49	1 - 3
			79018805 **	99	2 - 3
	79021963	18	79018812 **	49	5
			79018805 **	99	5
JX1060C - JX1095C	Factory Bracket	----	None	----	
	79018823	44	79018775 *	100	14
	79023241	68	79018794	98	10
			79018775 *	100	16
79018824	192	79018809 ***	88	10	
JX55 - JX95	Factory Bracket	----	79023228	100	10
	79018823	44	79018775 *	100	14
	79023241	68	79018794	98	10
			79018775 *	100	16
79018824	192	79018809 ***	88	10	
JX1075N & JX1095N	Factory Bracket	----	79023228	100	10
	79023239	44	79018775 *	100	16
JX1080U - JX1100U	Factory Bracket	----	79023228	100	10
	79023239	44	79018775 *	100	16
MXU100 - MXU135	Factory Bracket	----	79023228	100	16
	79018823	44	79018775 *	100	14
	79023241	68	79018794	98	10
			79018775 *	100	16
79018824	192	79018809 ***	88	10	
MXM120 - MXM190	Factory Bracket	----	79023228	100	16
	79018823	44	79018775 *	100	14
	79023241	68	79018794	98	10
			79018775 *	100	16
79018824	192	79018809 ***	88	10	
Puma 165 - 210	Factory Bracket	----	79023228	100	16
	79018823	44	79018775 *	100	14
	79023241	68	79018794	98	10
			79018775 *	100	16
79018824	192	79018809 ***	88	10	
MX210 - MX305	Factory Bracket	----	79023228	100	10/18
STX275 - STX530	Factory Bracket	----	N/A	----	----

* Order hardware kit separately – Part no. 79018850 – 1 per 2 wts.

** Order hardware kit separately – Part no. 79018849 – 1 per wt.

*** Order attaching pin separately – Part n. 79018848 – 1 per bracket

Case

(Current Production Tractors)

Wheel Weights

Tractor Model	Wheel Size	Hole Pattern	Part No.	Lbs. per Weight	Inside/Outside	Comments
DX18E - DX25E	12"	4 @ 6 1/8"	79018800	70	O	
D/DX25 - D/DX45	16"	None	N/A	-----		
	16.5"	3 @ 8 1/8"	79018826	66	O	Stacks
	19.5"	3 @ 10 1/2"	79018829	75	O	Stacks
	24" Ind.	4 @ 9 1/2"	79018831	107	O	Stacks
	24" Ag.	4 @ 11 1/2"	79018831	107	O	Stacks
JX1060C - JX1095C	28" - 38"	3 @ 14"	79018833	108	O	Stacks
JX55 - JX95	28" - 38"	3 @ 14"	79018833	108	O	Stacks
JX1075N & JX1095N	---	----	TBA	-----	-----	
JX1080U - JX1100U	28" - 38"	3 @ 14"	79018833	108	O	Stacks
MXU100 - MXU135	34 & 38" Flange	3 @ 12 3/4"	79018841	115	O	Stacks
	38" - 46" Bar	3 @ 14 5/8"	79018788	163	O	Stacks
MXM120 - MXM190	34 & 38" Flange	3 @ 12 3/4"	79018841	115	O	Stacks
	38" - 46" Bar	3 @ 14 5/8"	79018788	163	O	Stacks
Puma 165 - 210	34 & 38" Flange	3 @ 12 3/4"	79018841	115	O	Stacks
	38" - 46" Bar	3 @ 14 5/8"	79018788	163	O	Stacks
MX210 - MX305	38" - 46"	3 @ 22 1/2"	79018789	142	I/O	Stacks
			79018790		I/O	Stacks
			79018846		I/O	Stacks
STX275 - STX530	42" - 46"	3 @ 22 1/2"	79018789	142	I/O	Stacks
			79018790		I/O	Stacks
			79018846		I/O	Stacks
Industrial Tractors	28" Steel	4 @ 11 1/2"	79018838	146	O	Stacks
			79018836	500	O	

Skid Steer Loaders

Non-Current

Loader Model	Bracket No.	Lbs. Each	Weight No.	Lbs. Each	Weights per Bracket
1818 - 1845C	----	----	79018776	146	Rear Counter weight

Case

(Non-Current Production Tractors) Front End Weights and Brackets

Tractor Model	Bracket No.	Lbs. Each	Weight No.	Lbs. Each	Weights per bracket
1120 - 1140 235 - 265	Standard Equip.	-----	79018781	41	-----
395 - 995 385 - 885	79018774 (Angle iron included)	53	79018794	98	9
3220, 3230 4210 - 4240	79018772	50	79018775	100	12
5220 - 5250	79018772	50	79018775	100	12
C50 - C100 CX50 - CX100	79018772	50	79018775	100	12
JX80U - JX100U	Factory Bracket	----	79023228	100	10
	79023239	----	79018775	100	14
MX80C – MX100C MX100 – MX170	79018772	50	79018775	100	12
7210 – 7250	79023240	67	79018775	100	18
MX180 – MX270	N/A	-----	N/A	-----	-----
8910 - 8950	79023240	67	79018775	100	18
9330 - 9390	Fact. Front Bkt	-----	79018775	100	18 - 30
	Fact. Rear Upper Bkt.	-----	79018775	100	14 - 18
	Fact. Rear Lower Bkt.	-----	79018775	100	21 - 24

Wheel Weights

Tractor Model	Wheel Size	Hole Pattern	Part No.	Lbs. per Weight	Inside/ Outside	Comments
1120 - 1140	18" & 24"	3 @ 9 7/8"	79018829	75	O	Stacks
			79023243	80	O	Stacks
395 - 995 385 - 885	16"	4 @ 7 1/2"	79018840	45	I	2 wd - Front wh.
			79018826	101	O	Ag. Tire only
			79018831	107	O	Stacks
			79018834	125	I/O	Stacks
3220, 3230 4210 - 4240	16"	4 @ 7 1/2"	79018826	66	O	Ag. Tire only
			79018826	101	O	Ag. Tire only
			79018831	107	O	Stacks
			79018834	125	I/O	Stacks
5220 - 5250	30" – 38" Steel	3 @ 14 5/8"	79018788	163	I/O	Stacks
	34" & 38" Cast	4 @ 8 1/2"	79018843	150	I/O	Stacks
C50 - C100 CX50 - CX100	16" Front	4 @ 7 1/2"	79018826	66	O	Stacks
			79018840	45	I	2 wd - 4 pc. set
	24" & 26"	4 @ 9 1/2"	79018831	107	O	Stacks
	28" – 38"	4 @ 11 3/8"	79018834	125	I/O	Stacks
		4 @ 12"	79018831	107	I/O	Stacks

Case

(Non-Current Production Tractors) Wheel Weights - Continued

Tractor Model	Wheel Size	Hole Pattern	Part No.	Lbs. per Weight	Inside/Outside	Comments
JX80U - JX100U	16" Front	4 @ 7 1/2"	79018840	45	I	2 wd. - 4 pc. Set
			79018826	66	O	2 or 4 wd
	28 - 38"	3 @ 14"	79018833	108	O	Stacks
MX80C - MX100C MX100 - MX170	16" Front	4 @ 7 1/2"	79018826	66	O	Stacks
			79018840	45	I	2 wd - 4 pc. set
	34" - 46" Steel	3 @ 21 5/8"	N/A	-----		
7210 - 7250	32" - 46"	4 @ 8 1/2"	79018843	150	I/O	Stacks
MX180 - MX270	38" - 46" Steel	3 @ 21 5/8"	N/A	-----		
8910 - 8950	16" Front	4 @ 7 1/2"	79018826	66	O	Stacks
			79018840	45	I	2 wd - 4 pc. set
	38" - 46" Cast	4 @ 8 1/2"	79018843	150	I/O	Stacks
9330 - 9390	42" - 46"	No Holes	NA	----	----	

Counter Weights for Caterpillar Skid Steers

Add up to 440 lbs. of counter weights to increase lift capacity



Model	Bracket No.	Lbs. Each	Weight No.	Lbs. Each	Max. Weights per Bkt
216 - 268 216B - 268B	79023230	20	79018812 *	50	4 (2 per side)
252 - 268 252B - 268B	79018771	40	79018812 *	50	8 (4 per side)

*Order attaching hardware separately - Part no. 79018849

Challenger

(Current Production Tractors)

Front End Weights and Brackets

Tractor Model	Bracket No.	Lbs. Each	Weight No.	Lbs. Each	Max. weights / bkt.
MT225B - MT295B	79023233	25	79018781	41	6
			79018782	70	6
MT315B - MT345B	Factory Bracket	----	79018766	62	
			79018767	87	
MT425B - MT465B	Factory Bracket	----	79018766	62	15
			79018767	87	15
MT525B - MT545B (Non Tier 3 Engine)	Factory Bracket	----	79018766	62	15
			79018767	87	15
			79023005	123	15
MT555B - MT575B (Tier 3 Engine)	Factory Bracket	----	79024963	100	
MT635B - MT665B	Factory Bracket	----	79024963	100	18
MT745B - MT765B	Factory Bracket	----	79024963	100	20
MT835B - MT875B	Factory Bracket	----	79024963	100	32
MT945B - MT975B	Factory Bracket	----	79024963	100	32

Wheel Weights

Tractor Model	Wheel Size	Hole Pattern	Part No.	Lbs. per Weight	Inside/ Outside	Comments	
MT225B - MT295B	16" Front	4 @ 7 1/2"	79018840	45	I	4 pc. Set	
			79018826	66	O	Stacks	
	16" Ag.	3 @ 9 1/4"	79023243	80	I/O	Stacks	
			4 @ 7 1/2"	79018826	66	O	Stacks
	24" Ag.	4 @ 9 1/2"	79018831	107	I/O	Stacks	
	15" & 16" Turf	None	----	----	----		
	20" Turf	3 @ 11 3/4"	79018829	75	O	Stacks	
			79023243	80	O	Stacks	
	16.5" & 18" Ind.	4 @ 9 1/2"	79018831	107	I/O	Stacks	
			4 @ 7 1/2"	79018826	66	O	Stacks
24" Ind.	4 @ 9 1/2"	79018831	107	I/O	Stacks		
MT315B - MT345B	30"	None	79018831	107	I/O	Stacks – Holes must be drilled	
			79018838	146	I/O	Stacks – Holes must be drilled	
			4 @ 11"	79018831	107	I/O	Stacks
			79018838	146	I/O	Stacks	
MT425B - MT465B	30" – 38" Steel	3 @ 14"	79018833	108	I/O	Stacks	
MT525B - MT565B	34" – 50" Steel	3 @ 14"	79018833	108	I/O	Stacks – Flange axle - man. Adj.	
			4 @ 12 3/4"	79018834	125	O	Stacks – Flange axle - fixed
			None	----	----	----	
	38" – 50" Cast	4 @ 12 3/4"	79018839	148	O	Stacks	
MT635B --MT665B	38" – 54" Steel	4 @ 12 3/4"	N/A	----	I		
			79018834	125	O	Stacks	
	38" – 54" Cast	4 @ 12 3/4"	79018839	148	O	Stacks	
3 @ 17 1/2"			N/A	----	I		
MT745B - MT765B	N/A	N/A	----	----	----		
MT835B - MT875B	N/A	N/A	----	----	----		
MT945B - MT975B							

Challenger

(Non-Current Production Tractors)

Front End Weights and Brackets

Tractor Model	Bracket No.	Lbs. Each	Weight No.	Lbs. Each	Max. Wts. / Bkt.
MT225 - MT295	Factory Bracket	----	79018781	41	4
			79018782	70	4
MT425 - MT465	Factory Bracket	----	79018766	62	15
			79018767	87	15
MT535 - MT565	Factory Bracket	----	79018766	62	15
			79018767	87	15
			79023005	123	15
MT555B - MT575B (Non Tier 3 Engine)	Factory Bracket	----	79018766	62	15
			79018767	87	15
			79023005	123	15
MT635 - MT665	Factory Bracket	----	79018766	62	15
			79018767	87	15
			79023005	123	15
MT735 - MT765	Factory Bracket	----	79024963	100	20
MT835 - MT865	Factory Bracket	----	79024963	100	32

Wheel Weights

Tractor Model	Wheel Size	Hole Pattern	Part No.	Lbs. per Weight	Inside/Outside	Comments
MT225 – MT295	16" Front	4 @ 7 ½"	79018840	45	I	2 wd. – 4 pc. set
			79018826	66	O	Stacks
	15" & 16" Turf	None	----	----	----	
	16.5" & 19.5" Ind.	None	----	----	----	
	24" Ag.	4 @ 9 ¼"	79018829	75	I/O	Stacks
	24" Ind.	None	----	----	----	
MT425 – MT465	30" – 38"	3 @ 14"	79018833	108	I/O	Stacks
38" – 54" Steel – Bar Axle	None	----	----	----		
						38" Cast
MT635 – MT665	38" – 54" Steel – Bar Axle	None	----	----	----	
						38" Cast
MT735 – MT765			None Available - Tracks			
						MT835 – MT865

Cub Cadet

(Current Production Tractors)

Front End Weights and Brackets

Tractor Model	Bracket No.	Lbs. Each	Weight No.	Lbs. Each	Max. Wts. / Bkt.
LT1040 - LT1050	N/A	----	N/A	----	----
SLT1550, SLT1554 & GT1554	N/A	----	N/A	----	----
GT2542 - GT2554	79021942 (190-307)	11	79018781 (190-390)	41	4
GT3100 & GT3200	79026669 (190-413)	12	79018781 (190-390)	41	4
5234D - 5264	79023247 (590-821)	16	79018781 (190-390)	41	6
6284D	Standard Equip.	----	79018781 (190-390)	41	5
7530 & 7532	Standard Equip.	----	79018781 (190-390)	41	5
8354 & 8454	7004	15	79018795 *	52	5
			79018796 *	77	5

* Order attaching hardware separately – Part no. 79021726

Wheel Weights

Tractor Model	Wheel Size	Hole Pattern	Part No.	Lbs. per Weight	Inside/Outside	Comments
LT1040 - LT1050	20 x 10 - 8	None	N/A	----	----	
SLT1550, SLT1554 & GT1554	22 x 9.5 – 12"	4 @ 6 1/8"	79018800 **	70	O	
	23 x 10.5 – 12"	4 @ 6 1/8"	79018800 **	70	O	
GT2542 - GT2554	23 x 9.5 – 12"	4 @ 6 1/8"	79018800 **	70	O	
GT3100 & GT3200	23 x 9.5 – 12"	4 @ 6 1/8"	79018800 **	70	O	
	24 x 10.5 – 12"	4 @ 6 1/8"	79018800 **	70	O	
5234D - 5264	26 x 12 x 12"	4 @ 6 1/8"	79018800 **	70	O	Bar & Turf Tire
6284D	31 x 12 x 15"	None	----	----	----	Turf Tire
	10 x 16.5"	None	----	----	----	Ind. Tire
7530 & 7532	11.2 x 24"	3 @ 9 1/2"	79018829	75	O	Ag. Tire - Stack
			79023243	80	O	Ag. Tire - Stack
	15 x 19.5	3 @ 9 1/2"	79018829	75	O	Ind. Tire - Stack
			79023243	80	O	Ind. Tire - Stack
13.6 x 16"	4 @ 7 1/2"	79018826	66	O	Turf Tire - Stack	
8354 & 8454	24"	3 @ 9 1/2"	79018829	75	O	Ag. & Ind. - Stack
			79023243	80	O	Ag. & Ind. - Stack
	21.5 x 16.1"	None	----	----	----	Turf Tire
	41 x 14 – 20"	4 @ 7 1/2"	79018826	66	O	Turf Tire - Stack
79018826			101	O	Turf Tire - Stack	

** Order attaching hardware separately – Part No. 79018851

Cub Cadet

(Non-Current Production Tractors)

Front End Weights and Brackets

Tractor Model	Bracket No.	Lbs. Each	Weight No.	Lbs. Each	Weights per Bkt.
1027, 1170	N/A	----	----	----	----
LT1018 - LT1022 GT1222	N/A	----	----	----	----
1300 & 1405	N/A	----	----	----	----
1515 & 1517	N/A	----	----	----	----
1600 & 1800	N/A	----	----	----	----
1440 - 1864	N/A	----	----	----	----
1782 - 2086	N/A	----	----	----	----
2130 - 2186 2206 2518 - 2523	79021942 Front and Rear	12	79018781	41	4
3165, 3186, 3204 - 3235	79026669 Front and Rear	12	79018781	41	4
7000, 7200 & 7205	Standard Equip.	----	79018781	41	5
7192 - 7195	Standard Equip.	----	79018781	41	5
7232 - 7235	Standard Equip.	----	79018781	41	5
7252 & 7254	Standard Equip.	----	79018781	41	5
7260 & 7265	Standard Equip.	----	79018781	41	5
7264 & 7284	79023246 (590-490)	12	79018781 (190-390)	41	6
7272 - 7275	Standard Equip.	----	79018781	41	5
7300, 7305 & 7360	Standard Equip.	----	79018781	41	5
8404	7004	15	79018795 *	52	5
			79018796 *	77	5

* Order attaching hardware separately – Part no. 79021726

Cub Cadet

(Non-Current Production Tractors)

Wheel Weights

Tractor Model	Wheel Size	Hole Pattern	Part No.	Lbs. per Weight	Inside/Outside	Comments
1027, 1170	16 x 6.5"	None	----	----	----	
LT1018 – LT1022	20 x 9.0 – 8"	None	----	----	----	
GT1222	23 x 9.5 – 12"	4 @ 6 1/8"	79018800 **	70	O	
1300 & 1405 1515 & 1517 1600 & 1800	8" & 10"	None	----	----	----	
1440 - 1864	23x10.5-12"	4 @ 6 1/8"	79018800**	70	O	
1782 – 2086	26x12-12"	4 @ 6 1/8"	79018800**	70	O	
2130 - 2186	20x9.0-8"	None	----	----	----	----
2206	23x9.5-12"	4 @ 6 1/8"	79018800**	70	O	
2518 - 2523	20x8.5-12"	None	----	----	----	----
	23x8.5-12"	None	----	----	----	----
3165, 3186, 3204 - 3235	23x10.5-12"	4 @ 6 1/8"	79018800**	70	O	
	24x10.5-12"	4 @ 5 1/4"	79018800**	70	O	
7000, 7200 & 7205	9.5 – 16"	4 @ 7 1/2"	79018826	66	O	Ag. Tire - Stack
	33 x 12.5 – 15"	4 @ 7 1/2"	79018826	66	O	Turf Tire - Stack
	12 – 16.5"	None	----	----	----	Ind. tire
7192 - 7195	9.5 x 16" R1	4 @ 7 1/2"	79018826	66	O	Ag. Tire - Stack
	33x12.5-15"	4 @ 7 1/2"	79018826	66	O	Turf Tire - Stack
7232 - 7235	9.5 x 16" R1	3 @ 9 7/8"	79018829	75	O	Ag. Tire - Stack
			79023243	80	O	Stack
	13.6 x 16"	4 @ 7 1/2"	79018826	66	O	Ag. Tire - Stack
7252 & 7254	15"	None	----	----	----	Turf Tire
	9.5 – 16"	4 @ 7 1/2"	79018826	66	O	Ag. Tire - Stack
			79018826	101	O	Stacks
	12 – 16.5"	None	----	----	----	Ind. tire
7260 & 7265	11.2 - 24"	3 @ 9 7/8"	79018829	75	O	Ag. Tire - Stack
			79023243	80	O	Stack
	12.4 – 24"	None	----	----	----	
	13.6 – 16"	4 @ 7 1/2"	79018826	66	O	Turf Tire - Stack
	41 x 14 – 20"		79018826	101	O	Turf Tire - Stack
	15.0 – 19.5"	None	----	----	----	Ind. Tire
		3 @ 9 7/8"	79018829	75	O	Ind. Tire – Stack
			79023243	80	O	Stack
7264 & 7284	31 x 12 x 15"	None	----	----	----	Turf Tire
	10 x 16.5"	None	----	----	----	Ind. Tire
7272 – 7275 7300, 7305 & 7360	24"	3 @ 9 7/8"	79018829	75	O	Ag. Tire - Stack
			79023243	80	O	Stack
	20"	4 @ 7 1/2"	79018826	66	O	Turf Tire - Stack
			79018826	101	O	Turf Tire - Stack
	14.9 – 24"	None	----	----	----	Ind. tire
8404	24"	3 @ 9 1/2"	79018829	75	O	Ag. & Ind. - Stack
			79023243	80	O	Ag. & Ind. - Stack
	21.5 x 16.1"	None	----	----	----	Turf Tire
	44 x 18 – 20"	4 @ 7 1/2"	79018826	66	O	Turf Tire - Stack
			79018826	101	O	Turf Tire - Stack

** Order attaching hardware separately – Part No. 79018851

Gehl

(Current Production Tractors)

Rear Counter Weights

Tractor Model	Weight No.	Replaces Gehl Weight No.	Lbs. Each	Comments
3635 & 3935	N/A	808383	125	
4640 & 4840	79023232	810415	222	Includes hardware
5640 & 6640	79023238	810409	400	Includes hardware
7810	N/A	None	----	



79023232



79023238

Gehl

(Non-Current Production Tractors)

Rear Counter Weights

Tractor Model	Weight No.	Replaces Gehl Weight No.	Lbs. Each	Comments
3725 & 3825	N/A	None	----	
4635 & 4835	79021564	----	197	Includes hardware
5635 & 6635	79021565	----	344	Includes hardware
7600, 7800 & 7610	N/A	None	----	



9005



79021565

John Deere

(Current Production Tractors)

Front End Weights and Brackets

Tractor Model	Bracket No.	Lbs. Each	Weight No.	Lbs. Each	Max. Wts. Per Bkt.
790 & 990	Standard Equip.	----	79018781 (R66949)	41	5
			79018782 (BM19780)	70	5
2210, 2305, 2320 & 2520	Standard Equip.	----	79018781 (R66949)	41	5
			79018782 (BM19780)	70	5
3203	Standard Equip.	----	79018781 (R66949)	41	5
			79018782 (BM19780)	70	5
3120 - 3720	Standard Equip.	----	79018781 (R66949)	41	5
			79018782 (BM19780)	70	5
4120 - 4720	Standard Equip.	----	79018781 (R66949)	41	5
			79018782 (BM19780)	70	5
5103 – 5403	79018787	110	79018792 (R51680)	100	8
			79018793 (R58823)	100	10
5105 & 5205	79018787	110	79018792 (R51680)	100	8
			79018793 (R58823)	100	10
5225 - 5525	79018787	110	79018792 (R51680)	100	8
			79018793 (R58823)	100	10
5325N – 5525N	79018787	110	79018792 (R51680)	100	8
			79018793 (R58823)	100	10
6403 & 6603	79018784	123	79021563 (R127764)	100	14
6215 - 6715	Factory Bracket	220	79021563 (R127764)	100	18
	TBA	----	79021563 (R127764)	100	18
6230 - 6430	Factory Bracket	220	79021563 (R127764)	100	18
	TBA	----	79021563 (R127764)	100	18
7220 - 7520	Factory Bracket	220	79021563 (R127764)	100	18
	TBA	----	79021563 (R127764)	100	18
7630 - 7930	79023229	161	79021563 (R127764)	100	20
8130 - 8530	Use Factory Bracket	----	79021563 (R127764)	100	22
8230T – 8430T	Use Factory Bracket	----	79021563 (R127764)	100	22
9120 - 9620	79023229 *	161	79021563 (R127764)	100	20
	Rear Fact. Bkt. - RE71578	----	79021563 (R127764)	100	
9320T – 9620T	Use Factory Bracket	----	79021563 (R127764)	100	20

* Requires front frame reinforcement kit - RE213187

Skid Steer Loaders

Tractor Model	Bracket No.	Lbs. Each	Weight No.	Lbs. Each	Max. Wts. Per Bkt.
317 & 320	79018785	44	79018781 (R66949)	41	8 (4 per side)
325, 328 & 332	79026656	44	79018781 (R66949)	41	8 (4 per side)

Non-Current

240 & 250	79018785	44	79018781 (R66949)	41	8 (4 per side)
260, 270 & 280	79018786	48	79018781 (R66949)	41	8 (4 per side)
5575	79018814	31	79018812	50	4 – (2 per side)
6675 & 7775	79018813	32	79018781 (R66949)	41	8 - (4 per side)
			79018812	50	6 – (3 per side)
8875	79018813	42	79018781 (R66949)	41	10 - (5 per side)
			79018812	50	8 – (4 per side)
570, 575 & 675B	None	----	79018816	50	6 – (3 per side)

John Deere

(Current Production Tractors)

Wheel Weights

Tractor Model	Wheel Size	Hole Pattern	Part No.	Lbs. per Weight	Inside/Outside	Comments
L & G Tractors	12"	4 @ 6 1/8"	79018800 **	70	O	
790 & 990	16" Turf	None	----	----	----	
	19.5" Ind.	4 @ 7 1/2"	79018826	66	O	Stacks
			79018826	101	O	Stacks
	20" Turf	3 @ 11 3/4"	79018829	75	O	Stacks
			79023243	80	O	Stacks
	24" Ag	4 @ 9 1/2"	79018831 (T19293)	107	I/O	Stacks
None			----	----		
24" Ind.	4 @ 9 1/2"	79018831 (T19293)	107	I/O	Stacks	
2210, 2305, 2320 & 2520	12"	4 @ 6 1/8"	79018800 **	70	O	
	15" Turf					
	17.5" Ind.					
3203	19.5" Ind.	3 @ 11 1/2"	79018829	75	O	Stacks
3120 - 3720	16.1" Turf	None	----	----	----	
	20" Turf	3 @ 11 3/4"	79018829	75	O	Stacks
			79023243	80	O	Stacks
	24" Ag.	3 @ 9 7/8"	None	----	----	
	19.5" Ind.	3 @ 11 3/4"	None	----	----	
	20" Ind.	3 @ 11 3/4"	79018829	75	O	Stacks
4120 - 4720	16.1" Turf	None	----	----	----	
	20" Turf	3 @ 11 3/4"	79018829	75	O	Stacks
			79023243	80	O	Stacks
	28" Ag	4 @ 11 1/2"	79018831 (T19293)	107	I/O	Stacks
	24" Ind.	4 @ 9 1/2"	79018831 (T19293)	107	I/O	Stacks
5103 - 5303	28" Ag.	4 @ 11 1/2"	79018831 (T19293)	107	I/O	Stacks
5105 & 5205	16.1 Turf	None	----	----	----	
	24" Turf	4 @ 9 1/2"	79018831 (T19293)	107	I/O	Stacks
	28" Ag	4 @ 11 1/2"	79018831 (T19293)	107	I/O	Stacks
	24" Ind.	4 @ 9 1/2"	79018831 (T19293)	107	I/O	Stacks
5225 - 5525	16.1 Turf	None	----	----	----	
	24" Turf	4 @ 9 1/2"	79018831 (T19293)	107	I/O	Stacks
	24" Ag	4 @ 9 1/2"	79018831 (T19293)	107	I/O	Stacks
	28" - 38" Ag	4 @ 11 1/2"	79018831 (T19293)	107	I/O	Stacks
	24" Ind.	4 @ 9 1/2"	79018831 (T19293)	107	I/O	Stacks
5325N - 5525N	16.1 Turf	None	----	----	----	
	24" Turf	4 @ 9 1/2"	79018831 (T19293)	107	I/O	Stacks
	28" Ag	4 @ 11 1/2"	79018831 (T19293)	107	I/O	Stacks

** Order attaching hardware separately – Part no. 79018851

John Deere

(Current Production Tractors)

Wheel Weights – Continued

Tractor Model	Wheel Size	Hole Pattern	Part No.	Lbs. per Weight	Inside/Outside	Comments
6403 & 6603	34" & 38"	3 @ 14 5/8"	79018788 (L28228)	163	I/O	Stacks
6215 - 6715	30" - 42" Ag	4 @ 11 1/2"	79018831 (T19293)	107	I/O	Stacks
		3 @ 14 5/8"	79018788 (L28228)	163	I/O	Stacks
6230 - 6430	24" Turf	4 @ 9 1/2"	79018831 (T19293)	107	I/O	Stacks
	24" & 26" Ag	4 @ 9 1/2"	79018831 (T19293)	107	I/O	Stacks
	30" - 38" - Steel	4 @ 11 1/2"	79018831 (T19293)	107	I/O	Stacks
		3 @ 14 5/8"	79018788 (L28228)	163	I/O	Stacks
	42" Steel	3 @ 16 1/2"	79018835 (R61524)	115	I/O	Stacks
			79018845	573	O	
	30" - 38" - Cast	3 @ 16 1/2"	79018835 (R61524)	115	I/O	Stacks
			79018845	573	O	
7220 - 7520	32" - 54" Steel	3 @ 22 1/4"	79018789 (R167153)	142	I/O	Stacks
			79018790		I/O	Stacks
			79018846		I/O	Stacks
	32" - 54" Cast	3 @ 22 1/4"	79018789 (R167153)	142	I/O	Stacks
			79018790	500	I/O	Stacks
			79018846	700	I/O	Stacks
7630 - 7930	32" - 54" Steel	3 @ 22 1/4"	79018789 (R167153)	142	I/O	Stacks
			79018790		I/O	Stacks
			79018846		I/O	Stacks
	32" - 54" Cast	3 @ 22 1/4"	79018789 (R167153)	142	I/O	Stacks
			79018790	500	I/O	Stacks
			79018846	700	I/O	Stacks
8130 - 8530	32" - 54" Steel	3 @ 22 1/4"	79018789 (R167153)	142	I/O	Stacks
			79018790		I/O	Stacks
			79018846		I/O	Stacks
	32" - 54" Cast	3 @ 22 1/4"	79018789 (R167153)	142	I/O	Stacks
			79018790	500	I/O	Stacks
			79018846	700	I/O	Stacks
8230T - 8430T	N/A	-----	N/A	-----	-----	-----
9120 - 9620	38" - 50" Steel	3 @ 22 1/4"	79018789 (R167153)	142	I/O	Stacks
			79018790		I/O	Stacks
			79018846		I/O	Stacks
	38" - 50" Cast	3 @ 22 1/4"	79018789 (R167153)	142	I/O	Stacks
			79018790	500	I/O	Stacks
			79018846	700	I/O	Stacks
9320T - 9620T	N/A	-----	N/A	-----	-----	-----

John Deere

(Non-Current Production Tractors)
Front End Weights and Brackets

Tractor Model	Bracket No.	Lbs. Each	Weight No.	Lbs. Each	Max. Wts. / Bkt.
655 - 955	Standard Equip.	----	79018781 (R66949)	41	
			79018782 (BM19780)	70	
670 - 1070	Standard Equip.	----	79018781 (R66949)	41	
			79018782 (BM19780)	70	
650 - 1250	Standard Equip.	----	79018781 (R66949)	41	
			79018782 (BM19780)	70	
1450 - 2950	79018787 (R70417)	110	79018792 (R51680)	100	8
2155 - 3255	79018787 (R70417)	110	79018792 (R51680)	100	8
2840 - 4840	79018784 (R117599)	123	79021563 (R127764)	100	14
	79023229 (82549)	161	79021563 (R127764)	100	20
4050 - 4850	79018784 (R117599)	123	79021563 (R127764)	100	14
	79023229 (82549)	161	79021563 (R127764)	100	20
4055 - 4955	79018784 (R117599)	123	79021563 (R127764)	100	14
	79023229 (82549)	161	79021563 (R127764)	100	20
4100 - 4700 & 4100N	Standard Equip.	----	79018781 (R66949)	41	6 – 8
			79018782 (BM19780)	70	6 – 8
4010 - 4710	Standard Equip.	----	79018781 (R66949)	41	6 – 8
			79018782 (BM19780)	70	6 – 8
4115	Standard Equip.	----	79018781 (R66949)	41	5
			79018782 (BM19780)	70	50
4560 - 4960	79018784 (R117599)	123	79021563 (R127764)	100	14
	79023229 (82549)	161	79021563 (R127764)	100	20
5200 - 5500	79018787 (R70417)	110	79018792 (R51680)	100	8
5210 - 5310	79018787 (R70417)	110	79018792 (R51680)	100	8
5410 & 5510	79021938 (AR124753)	281	79018792 (R51680)	100	
5220 - 5320	79018787	110	79018792 (R51680)	100	8
5420 - 5520	79021938	281	79018792 (R51680)	100	10
5320N	79018787	110	79018792 (R51680)	100	8
5420N & 5520N	79021938	281	79018792 (R51680)	100	10
6200 - 6500	79018784 (R117599)	123	79021563 (R127764)	100	14
6405, 6605 & 7405	79018787 (R70147)	110	79021563 (R127764)	100	10
6110 - 6410 6110L - 6410L	79018787 (R70417)	110	79018792 (R51680)	100	8
6120 - 6420	79018787 (R70417)	110	79021563 (R127764)	100	10
6120L - 6520L	79018787 (R70417)	110	79021563 (R127764)	100	10
7200 - 7800	79018784 (R117599)	123	79021563 (R127764)	100	14
	79023229 (82549)	161	79021563 (R127764)	100	20
7210 - 7810 7210HC - 7510HC	79018784 (R117599)	123	79021563 (R127764)	100	14
	79023229 (R82549)	161	79021563 (R127764)	100	20
7720 - 7920	79023229	161	79021563 (R127764)	100	20
8100 - 8400	79018784 (R117599)	123	79021563 (R127764)	100	14
	79023229 (82549)	161	79021563 (R127764)	100	20
8110 - 8410	79018784 (R117599)	123	79021563 (R127764)	100	14
	79023229 (82549)	161	79021563 (R127764)	100	20
8120 - 8520	79023229	161	79021563 (R127764)	100	20
8120T - 8520T	79023229	161	79021563 (R127764)	100	20
8450 - 8850	79018784 (R117599)	123	79021563 (R127764)	100	14
	79023229 (82549)	161	79021563 (R127764)	100	20
8560 - 8960	79018784 (R117599)	123	79021563 (R127764)	100	14
	79023229 (82549)	161	79021563 (R127764)	100	20
9100 - 9400	79023229 *	161	79021563 (R127764)	100	20
	Rear Fact. Bkt. - RE71578	----	79021563 (R127764)	100	

* Requires front frame reinforcement kit - RE213187

John Deere

(Non-Current Production Tractors)

Wheel Weights

Tractor Model	Wheel Size	Hole Pattern	Part No.	Lbs. per Weight	Inside/Outside	Comments
L & G Tractors	12"	4 @ 6 1/8"	79018800	70	O	
650 - 1450	16" Ag.	4 @ 7 1/2"	79018826 (BM17965)	66	O	Stacks
655 - 955	24" - 28"	3 @ 9 7/8"	79018829 (BM17968)	75	O	Stacks
670 - 1070		4 @ 11 1/2"	79018831 (T19293)	107	I/O	Stacks
	30"	4 @ 11 1/2"	79018831 (T19293)	107	I/O	Stacks
			79018838	146	O	Stacks
2150 - 2950	24" - 30"	4 @ 11 1/2"	79018831 (T19293)	107	I/O	Stacks
	28" - 38"	3 @ 16 1/2"	79018835 (R61524)	115	I/O	Stacks
2155 - 3255	24" - 30" Steel	4 @ 9 1/2"	79018831 (T19293)	107	I/O	Stacks
		4 @ 11 1/2"	79018831 (T19293)	107	I/O	Stacks
	30" Cast	3 @ 16 1/2"	79018835 (R61524)	115	I/O	Stacks
	34" Cast	3 @ 16 1/2"	79018835 (R61524)	115	I/O	Stacks
			79018845	573	O	
4050 - 4850	23" - 42"	3 @ 16 1/2"	79018835 (R61524)	115	I/O	Stacks
4055 - 4955	32" - 50"	3 @ 22 1/4"	79018789 (R167153)	142	I/O	Stacks
			79018790 (R167152)	500	I/O	Stacks
			79018846	700	I/O	Stacks
4100 - 4700	15" Turf	----	N/A			
	16" Ag.	4 @ 7 1/2"	79018826 (BM17965)	66	O	Stacks
	16.1" Turf	None	----	----	----	
	16.5" Ind.	4 @ 7 1/2"	79018826	66	O	Stacks
	17.5" & 19.5" Ind.	4 @ 7 1/2"	79018826 (BM17965)	66	O	Stacks
	20" Turf	3 @ 9 7/8"	79018829 (BM17968)	75	O	Stacks
		4 @ 7 1/2"	79018826 (BM17965)	66	O	Stacks
			79018826	101	O	Stacks
	24"	3 @ 9 7/8"	79018829 (BM17968)	75	O	Stacks
		4 @ 9 1/2"	79018831 (T19293)	107	I/O	Stacks
	28"	4 @ 11 1/2"	79018831 (T19293)	107	I/O	Stacks
4010 - 4710	15" Turf	4 @ 7 1/2"	N/A	----	----	----
	16" Turf & Ag	4 @ 7 1/2"	79018826 (BM17965)	66	O	Stacks
	16.1" Turf	None	----	----	----	----
	16.5", 17.5" & 19.5" Ind.	None	----	----	----	----
	20" Turf	3 @ 11 3/4"	79018826 (BM17965)	66	O	Stacks
			79018829 (BM17968)	75	O	Stacks
			79023243	80	O	Stacks
			79018826 (BM17965)	66	O	Stacks
	24" Ag.	3 @ 9 7/8"	79018826	101	O	Stacks
			79018829 (BM17969)	75	O	Stacks
			79023243	80	O	Stacks
		4 @ 9 1/2"	79018831 (T19293)	107	I/O	Stacks
	24" Ind.	4 @ 9 1/2"	79018831 (T19293)	107	I/O	Stacks
	28" Ag.	4 @ 11 1/2"	79018831 (T19293)	107	I/O	Stacks
4115	16" Turf	4 @ 7 1/2"	None	----	----	----
	16.5" Ag. & Ind.	None	----	----	----	----
			4 @ 7 1/2"	79018826 (BM17965)	66	O

John Deere

(Non-Current Production Tractors)
Wheel Weights - Continued

Tractor Model	Wheel Size	Hole Pattern	Part No.	Lbs. per Weight	Inside/Outside	Comments
4560 - 4960	32" - 50"	3 @ 22 1/4"	79018789 (R167153)	142	I/O	Stacks
			79018790 (R167152)	500	I/O	Stacks
			79018846	700	I/O	Stacks
5200 - 5500	24" - 30"	4 @ 11 1/2"	79018831 (T19293)	107	I/O	Stacks
5210 - 5510	24" - 30"	4 @ 11 1/2"	79018831 (T19293)	107	I/O	Stacks
	Steel or Cast					
	34" & 38" Cast	3 @ 16 1/2"	79018835 (R61524)	115	I/O	Stacks
			79018845	573	O	
5220 - 5520	16.1" - Turf	None	----	----	----	----
	24"	4 @ 9 1/2"	79018831 (T19293)	107	I/O	Stacks
	Turf, Ag. & Ind.					
	28" - 30"	4 @ 11 1/2"	79018831 (T19293)	107	I/O	Stacks
	Steel or Cast					
	38" Steel	4 @ 11 1/2"	79018831 (T19293)	107	I/O	Stacks
	38" Cast	3 @ 16 1/2"	79018835	115	I/O	Stacks
			79018845	573	O	
5320N - 5520N	16.1" - Turf	None	----	----	----	----
	24" - Ag.	4 @ 9 1/2"	79018831 (T19293)	107	I/O	Stacks
	28" - Ag.	4 @ 11 1/2"	79018831 (T19293)	107	I/O	Stacks
6110 - 6410, 6110L - 6510L	30" - 38" Steel	4 @ 11 1/2"	79018831 (T19293)	107	I/O	Stacks
	30" Cast	3 @ 16 1/2"	79018835 (R61524)	115	I/O	Stacks
	34" & 38" Cast	3 @ 16 1/2"	79018835 (R61524)	115	I/O	Stacks
			79018845	573	O	
6200 - 6500	28" & 30" Steel	4 @ 11 1/2"	79018831 (T19293)	107	I/O	Stacks
			79018838	146	O	Stacks
	34" & 38" Steel	3 @ 14 5/8"	79018788 (L28228)	163	I/O	Stacks
	30" Cast	3 @ 16 1/2"	79018835 (R61524)	115	I/O	Stacks
	34" & 38" Cast	3 @ 16 1/2"	79018835 (R61524)	115	I/O	Stacks
			79018845	573	O	
6405, 6605 & 7405	34" & 38" - Steel	4 @ 11 1/2"	79018831 (T19293)	107	I/O	Stacks
			3 @ 16 1/2"	79018835 (R61524)	115	I/O
	38" - Cast	3 @ 16 1/2"	79018835 (R61524)	115	I/O	Stacks
	46" - Steel	3 @ 16 1/2"	79018835 (R61524)	115	I/O	Stacks
6120 - 6420 6120L - 6520L	24" Turf	4 @ 9 1/2"	79018831 (T19293)	107	I/O	Stacks
	24" & 26" Ag	4 @ 9 1/2"	79018831 (T19293)	107	I/O	Stacks
	30" - 38" - Steel	4 @ 11 1/2"	79018831 (T19293)	107	I/O	Stacks
			3 @ 14 5/8"	79018788 (L28228)	163	I/O
	42" Steel	3 @ 16 1/2"	79018835 (R61524)	115		Stacks
			79018845	573	O	
	30" - 38" - Cast	3 @ 16 1/2"	79018835 (R61524)	115		Stacks
			79018845	573		
	7200 - 7800	32" - 50"	3 @ 22 1/4"	79018789 (R167153)	142	I/O
79018790 * (R167152)				500	I/O	Stacks
79018846 *				700	I/O	Stacks
7210 - 7810 7210HC - 7810HC	32" - 50"	3 @ 22 1/4"	79018789 (R167153)	142	I/O	Stacks
			79018790 * (R167152)	500	I/O	Stacks
			79018846 *	700	I/O	Stacks

* Wheel weight center hole diameter is 15 1/4" - please check for possible obstruction

John Deere

(Non-Current Production Tractors)

Wheel Weights - Continued

Tractor Model	Wheel Size	Hole Pattern	Part No.	Lbs. per Weight	Inside/Outside	Comments
7720 - 7920	32" - 54" Steel & Cast	3 @ 22 1/4"	79018789 (R167153)	142	I/O	Stacks
			79018790 * (R167152)	500	I/O	Stacks
			79018846 *	700	I/O	Stacks
8100 - 8400	32" - 50"	3 @ 22 1/4"	79018789 (R167153)	142	I/O	Stacks
			79018790 * (R167152)	500	I/O	Stacks
			79018846 *	700	I/O	Stacks
8110 - 8410	32" - 50"	3 @ 22 1/4"	79018789 (R167153)	142	I/O	Stacks
			79018790 * (R167152)	500	I/O	Stacks
			79018846 *	700	I/O	Stacks
8120 - 8520	38" - 54" Steel & Cast	3 @ 22 1/4"	79018789 (R167153)	142	I/O	Stacks
			79018790 * (R167152)	500	I/O	Stacks
			79018846 *	700	I/O	Stacks
8120T - 8520T	N/A	-----	N/A	-----	-----	-----
8450 - 8850	32" - 50"	3 @ 16 1/2"	79018835	115	I/O	Stacks
		3 @ 22 1/4"	79018789 (R167153)	142	I/O	Stacks
			79018790 * (R167152)	500	I/O	Stacks
			79018846 *	700	I/O	Stacks
8560 - 8960	32" - 50"	3 @ 22 1/4"	79018789 (R167153)	142	I/O	Stacks
			79018790 * (R167152)	500	I/O	Stacks
			79018846 *	700	I/O	Stacks
9100 - 9400	32" - 46"	3 @ 22 1/4"	79018789 (R167153)	142	I/O	Stacks
			79018790 * (R167152)	500	I/O	Stacks
			79018846 *	700	I/O	Stacks

* Wheel weight center hole diameter is 15 1/4" - please check for possible obstruction

Kiote

(Current Production Tractors)

Front End Weights and Brackets

Tractor Model	Bracket No.	Lbs. Each	Weight No.	Lbs. Each	Max. Wts. / Bkt.
LB1914 & LK3054XS	79026668	15	79018795	41	5
			79018796	70	5
CK20 & CK20HST	79026658	15	79018795	52	5
			79018796	77	5
CK25 & CK25HST	79026658	15	79018795	52	5
			79018796	77	5
CK30 & CK30HST	79026658	15	79018795	52	5
			79018796	77	5
DK35	79026658	15	79018795	52	5
			79018796	77	5
DK40	79026658	15	79018795	52	5
			79018796	77	5
DK45S	79026660	14	79018795	52	5
			79018796	77	5
DK55	79026660	14	79018795	52	5
			79018796	77	5
DK65S	79026659	42	79018795	52	10
			79018796	77	10

Wheel Weights

Tractor Model	Wheel Size	Hole Pattern	Part No.	Lbs. per Weight	Inside/Outside	Comments
LB1914	12.4 – 16"	None	N/A	----	----	Ag. Tire
	9.5 x 20"	None	N/A	----	----	Ag. Tire
	36 x 13.5 – 15"	None	N/A	----	----	Turf Tire
	12.4 x 16"	None	N/A	----	----	Ind. Tire
LK3054XS	11.2 x 24"	3 @ 9 1/2"	79023243	80	I/O	Ag. Tire
	13.6 x 16.1"	None	----	----	----	Turf Tire
	41 x 14.0 – 20"	None	----	----	----	Turf Tire
	15 x 19.5"	None	----	----	----	Ind. Tire
CK20 & CK20HST	9.5 x 16"	None	----	----	----	Ag. Tire
	33 x 12.5 – 16.5"	None	----	----	----	Turf Tire
	12 – 16.5"	None	----	----	----	Ind. Tire
CK25 & CK25HST	11.2 x 24"	3 @ 9 1/2"	79023243	80	I/O	Ag. Tire
	41 x 14.0 – 20"	None	----	----	----	Turf Tire
	15 x 19.5"	None	----	----	----	Ind. Tire
CK30 & CK30HST	11.2 x 24"	3 @ 9 1/2"	79023243	80	I/O	Ag. Tire
	41 x 14.0 – 20"	None	----	----	----	Turf Tire
	15 x 19.5"	None	----	----	----	Ind. Tire
DK35	12.4 x 24"	3 @ 9 1/2"	79023243	80	I/O	Ag. Tire
	41 x 14.0 – 20"	None	----	----	----	Turf Tire
	43 x 16 – 20"	None	----	----	----	Ind. Tire

Kiote

(Current Production Tractors) Wheel Weights - Continued

Tractor Model	Wheel Size	Hole Pattern	Part No.	Lbs. per Weight	Inside/Outside	Comments
DK40	13.6 x 24"	3 @ 9 1/2"	79023243	80	I/O	Ag. Tire
	41 x 14.0 - 20"	None	----	----	----	Turf Tire
	14.9 x 24"	None	----	----	----	Ind. Tire
DK45S	14.9 x 24"	3 @ 9 1/2"	79023243	80	I/O	Ag. Tire
	21.5L x 16.1"	None	----	----	----	Turf Tire
	17.5L x 24"	3 @ 9 1/2"	79023243	80	I/O	Ag. Tire
DK55	14.9 x 28"	3 @ 12 3/4"	79018843	150	O	Ag. Tire
			79018837	300	I/O	
	44 x 18 - 20"	None	----	----	----	Turf Tire
	18.4 x 24"	4 @ 9 1/2"	79018831	107	I/O	Ind. Tire
DK65S	16.9 x 30"	3 @ 12 3/4"	79018843	150	O	Ag. Tire
			79018837	300	I/O	
	44 x 18 x 20"	None	----	----	----	Turf Tire
	18.4 x 24"	4 @ 9 1/2"	79018831	107	I/O	Ind. Tire

(Non-Current Production Tractors)

Front End Weights and Brackets

Tractor Model	Bracket No.	Lbs. Each	Weight No.	Lbs. Each	Max. Wts. / Bkt.
LK2554	79026668	15	79018795	41	5
			79018796	70	5
DK45	79026658	15	79018795	52	5
			79018796	77	5
DK50	79026658	15	79018795	52	5
			79018796	77	5
DK65	79026659	42	79018795	52	10
			79018796	77	10

Wheel Weights

Tractor Model	Wheel Size	Hole Pattern	Part No.	Lbs. per Weight	Inside/Outside	Comments
LK2554	9.5 x 24"	3 @ 9 1/2"	79023243	80	I/O	Ag. Tire
	11.2 x 24"	3 @ 9 1/2"	79023243	80	I/O	Ag. Tire
	41 x 14.0 - 20"	None	N/A	----	----	Turf Tire
	15 x 19.5"	None	----	----	----	Ind. Tire
DK45	14.9 x 24"	3 @ 9 1/2"	79023243	80	I/O	Ag. Tire
	21.5L x 16.1"	None	----	----	----	Turf Tire
	17.5L x 24"	3 @ 9 1/2"	79023243	80	I/O	Ind. Tire
DK50	14.9 x 24"	3 @ 9 1/2"	79023243	80	I/O	Ag. Tire
	21.5L x 16.1"	None	----	----	----	Turf Tire
	17.5L x 24"	3 @ 9 1/2"	79023243	80	I/O	Ind. Tire
DK65	16.9 x 30"	3 @ 12 3/4"	79018843	150	O	Ag. Tire
			79018837	300	I/O	
	44 x 18 - 20"	None	----	----	----	Turf Tire
	18.4 x 24"	4 @ 9 1/2"	79018831	107	I/O	Ind. Tire

Kubota

(Current Production Tractors)

Front End Weights and Brackets

Tractor Model	Bracket No.	Lbs. Each	Weight No.	Lbs. Each	Max. Wts. / Bkt.
BX1500	79018797 (BX8064)	21	79018795 * (BL8060)	52	5
			79018796 *	77	5
BX1830 & BX2230	79018797 (BX8064)	21	79018795 * (BL8060)	52	5
			79018796 *	77	5
BX1850 & BX2350	79018797 (BX8064)	21	79018795 * (BL8060)	52	5
			79018796 *	77	5
BX23 & BX24	79018797 (BX8064)	21	79018795 * (BL8060)	52	5
			79018796 *	77	5
B2410 – B2910	Standard Equip.	----	79018795 * (BL8060)	52	3
			79018796 *	77	3
B2630 & B3030	79018797 (BX8064)	21	79018795 * (BL8060)	52	3
			79018796 *	77	3
B7410 – B7610	Standard Equip.	----	79018795 * (BL8060)	52	3
			79018796 *	77	3
B7800	Standard Equip.	----	79018795 * (BL8060)	52	3
			79018796 *	77	3
B21, L39 & L48	N/A	----	N/A	----	----
L2800 & L3400	79023231	21	79018795 * (BL8060)	52	5
			79018796 *	77	5
L4400	79023236 (MX8068) (Standard on 2WD)	27	79018795 * (BL8060)	52	7
			79018796 *	77	7
L3130 – L5030	79023236 (MX8068) (Standard on 2WD)	27	79018795 * (BL8060)	52	7
			79018796 *	77	7
MX5000	79023236 (MX8068) (Standard on 2WD)	27	79018795 * (BL8060)	52	7
			79018796 *	77	7
M4800, M4900 & M5700	Fact. Bkt. (M8070)	----	79018799 (M8071) +	102	8
	79023245 (M8075)	72	79018799 (M8071) ++	102	10
	79018798	51	79018794 (M8091) ++++	98	9
			79018804 **	102	9
M5040, M6040 & M7040	79023245 (M8075)	72	79018799 (M8071) ++	102	10
	79018798	51	79018794 (M8091) ++++	98	9
			79018804 **	102	9
			79018804 **	102	9
M6800, M8200 & M9000	79023245 (M8075)	72	79018799 (M8071) ++	102	10
	79018798	51	79018794 (M8091) ++++	98	9
			79018804 **	102	9
			79018804 **	102	9
M8540 & M9540	79023245 (M8075)	72	79018799 (M8071) ++	102	10
	79018798	51	79018794 (M8091) ++++	98	9
			79018804 **	102	9
			79018804 **	102	9
M95S & M 105S	Standard Equip.	----	79018799 (M8071) +++	102	12
M105X & M125X	Standard Equip.	----	79018799 (M8071) +++	102	12
M-110 & M 120	79023244 (M9265)	142	79018799 (M8071) +++	102	12

* Order attaching hardware separately – part no. 79021726

** Order attaching hardware separately – part no. 79018850

+ Order attaching hardware separately – part no. 79018852

++ Order attaching hardware separately – part no. 79018853

+++ Order attaching hardware separately – part no. 79018854

++++ Order attaching hardware separately – part no. 79018855

Kubota

(Current Production Tractors)

Wheel Weights

Tractor Model	Wheel Size	Hole Pattern	Part No.	Lbs. per Weight	Inside/Outside	Comments
L & G Equip.	8"	None	----	----	----	
	12"	4 @ 6 1/8"	79018800 **	70	O	
BX1500	12"	4 @ 6 1/8"	79018800 **	70	O	
BX1830 & BX2230	12"	4 @ 6 1/8"	79018800 **	70	O	
BX1850 & BX2350	12"	4 @ 6 1/8"	79018800 **	70	O	
BX23 & BX24	12"	4 @ 6 1/8"	79018800 **	70	O	
B2410 – B2910	16" Ag.	4 @ 7 1/2"	79018826	66	O	Does not fit into wheel
	15" Turf	4 @ 7 1/2"	None	----	----	
	16" Turf	None	----	----	----	
	16" Ind.	None	----	----	----	
	16.5" Ind.	4 @ 7 1/2"	79018826	66	O	
B2630 & B3030	16" Ag.	4 @ 7 1/2"	79018826	66	O	Does not fit into wheel
	16" Turf	None	----	----	----	
	16" Ind.	None	----	----	----	
B7410 – B7610	16" Ag.	4 @ 7 1/2"	79018826	66	O	Does not fit into wheel
	15" Turf	4 @ 7 1/2"	None	----	----	
	16.5" Ind.	4 @ 7 1/2"	79018826	66	O	
B7800	16" Ag.	4 @ 7 1/2"	79018826	66	O	Does not fit into wheel
	16" Turf	None	----	----	----	
	16" Ind.	None	----	----	----	
B21, L39 & L48	16" Ag.	None	----	----	----	
	16" & 24" Turf	None	----	----	----	
	16" & 19.5" Ind.	None	----	----	----	
	24" Ind.	4 @ 11 1/2"	79018831 (LM8124)	107	I/O	Stacks
L2800, L3400 & L4400	16" Front	4 @ 7 1/2"	79018840	45	I	2 wd – 4 pc. Set
			79018826	66	O	Stacks
	24" Ag.	3 @ 8 7/8"	79018783 (L8066)	59	O	Stacks – 3 pr. max
	16" & 20" Turf	None	----	----	----	
	19.5" Ind.	None	----	----	----	
	24" Ind.	3 @ 8 7/8"	79018783 (L8066)	59	O	Stacks – 3 pr. max
L3130 - L5030	16" Front	4 @ 7 1/2"	79018840	45	I	2 wd – 4 pc. Set
			79018826	66	O	Stacks
	24" Ag.	3 @ 8 7/8"	79018783 (L8066)	59	O	Stacks – 3 pr. max
	26" & 28" Ag.	4 @ 9 1/2"	79018831 (LM8124)	107	I/O	Stacks
	16" & 20" Turf	None	----	----	----	
	24" Ind.	3 @ 8 7/8"	79018783 (L8066)	59	O	Stacks – 3 pr. max
MX5000	26" & 28" Ag.	4 @ 9 1/2"	79018831 (LM8124)	107	I/O	Stacks
	16" & 20" Turf	None	----	----	----	
	24" Ind.	4 @ 9 1/2"	79018831 (LM8124)	107	I/O	Stacks
M4800, M4900 & M5700	16" Front	4 @ 7 1/2"	79018840	45	I	2 wd – 4 pc. Set
			79018826	66	O	Stacks
	24" Ag., Turf, & Ind.	4 @ 9 1/2"	79018831 (LM8124)	107	I/O	Stacks
	28" Ag.	4 @ 11 1/2"	79018831 (LM8124)	107	I/O	Stacks
			79018838	146	I/O	Stacks
			79018836	500	O	
16.1" Turf	None	----	----	----		

** Order attaching hardware separately – part no. 79018851 (order 1 per weight)

Kubota

(Current Production Tractors)
Wheel Weights - Continued

Tractor Model	Wheel Size	Hole Pattern	Part No.	Lbs. per Weight	Inside/Outside	Comments
M5040, M6040 & M7040	24" Ag. - Steel	4 @ 9 1/2"	79018831 (LM8124)	107	I/O	Stacks
	28" & 30" Ag. Steel & Cast	4 @ 11 1/2"	79018831 (LM8124)	107	I/O	Stacks
			79018838	146	I/O	Stacks
			79018836	500	O	
	16.1" Turf	None	----	----	----	
	24" & 26" Turf	4 @ 9 1/2"	79018831 (LM8124)	107	I/O	Stacks
24" Ind.	4 @ 9 1/2"	79018831 (LM8124)	107	I/O	Stacks	
M6800, M8200 & M9000	24" Steel	3 @ 12 3/4"	79018837	300	I/O	Stacks
	24" Cast					
	28" Cast	4 @ 11 1/2"	79018831 (LM8124)	107	I/O	Stacks
			79018838	146	I/O	Stacks
			79018836	500	O	
	30" & 34" Steel & Cast	3 @ 12 3/4"	79018837	300	I/O	Stacks
			79018843	150	O *	Stacks
			79018837	300	I/O	Stacks
	4 @ 11 1/2"	4 @ 11 1/2"	79018831 (LM8124)	107	I/O	Stacks
			79018838	146	I/O	Stacks
			79018836	500	O	
	24" Ind.	4 @ 9 1/2"	79018831 (LM8124)	107	I/O	Stacks
M8540 & M9540	24" & 26" Ag. - Steel	4 @ 9 1/2"	79018831 (LM8124)	107	I/O	Stacks
	28" - 34" Steel & Cast	4 @ 11 1/2"	79018831 (LM8124)	107	I/O	Stacks
			79018838	146	I/O	Stacks
			79018836	500	O	
	24" Ind.	4 @ 9 1/2"	79018831 (LM8124)	107	I/O	Stacks
	M95S & M105S	24" & 26" Ag. - Steel	4 @ 9 1/2"	79018831 (LM8124)	107	I/O
30" & 34" Steel & Cast		4 @ 11 1/2"	79018831 (LM8124)	107	I/O	Stacks
			79018838	146	I/O	Stacks
			79018836	500	O	
M105X & M125X	34" & 38" Steel & Cast	4 @ 11 1/2"	79018831 (LM8124)	107	I/O	Stacks
			79018838	146	I/O	Stacks
			79018836	500	O	
M-110 & M-120	34" & 38" Cast	4 @ 12 3/4"	79018834*	125	I/O	Stacks
			79018839*	148	I/O	Stacks

* Will Mount inside or outside on 34" wheels.

Kubota

(Non-Current Production Tractors) Front End Weights and Brackets

Tractor Model	Bracket No.	Lbs. Each	Weight No.	Lbs. Each	Max. Wts. / Bkt.
BX22	79018797 (BX8064)	21	79018795 * (BL8060)	52	5
			79018796 *	77	5
BX1800 - BX2200	79018797 (BX8064)	21	79018795 * (BL8060)	52	5
			79018796 *	77	5
L35	N/A	----	N/A	----	----
B1550 - B2150	Standard Equip.	----	79018795 * (BL8060)	52	3
			79018796 *	77	3
B1700 - B7300	Standard Equip.	----	79018795 * (BL8060)	52	3
			79018796 *	77	3
B4200 - B9200	Standard Equip.	----	79018795 * (BL8060)	52	5
			79018796 *	77	5
B7400 - B7600	Standard Equip.	----	79018795 * (BL8060)	52	3
			79018796 *	77	3
L2350 - L3650	Standard Equip.	----	79018795 * (BL8060)	52	8
			79018796 *	77	8
L2500 - L4200	Standard Equip.	----	79018795 * (BL8060)	52	8
			79018796 *	77	8
L2600, L3000 & L4300	79023231	21	79018795 * (BL8060)	52	5
			79018796 *	77	5
L3010 - L4610	79023231	21	79018795 * (BL8060)	52	5
			79018796 *	77	5
L4350	Fact. Bkt. (L9404G)	----	79018795 * (BL8060)	52	8
			79018796 *	77	8
L4850 & L5450	Fact. Bkt. (L9404G)	----	79018795 * (BL8060)	52	8
			79018796 *	77	8
M4030 - M6030	79018798	51	79018794 (M8091) (Hwd. - 79018855)	98	9
			79018804 **	102	9
M7030N & M7030DTN-B	Fact. Bkt. (M8086)	----	79018795 * (BL8060)	52	8
			79018796 *	77	8
M7030N & M7030SUDT & M8030	79018798	51	79018794 (M8091) (Hwd. - 79018855)	98	9
			79018804 **	102	9
M4700 & M5400	Fact. Bkt. (M8070)	----	79018799 (Hwd. - 79018852)	102	8
			79023245 (M8075)	72	10
	79018798	51	79018794 (M8091) (Hwd. - 79018855)	98	9
			79018804 **	102	9
M4950 - M8950	79018798	51	79018794 (M8091) (Hwd. - 79018855)	98	9
			79018804 **	102	9
M7580 - M9580	79018798	51	79018794 (M8091) (Hwd. - 79018855)	98	9
			79018804 **	102	9

* Order attaching hardware separately – Part no. 79021726

** Order attaching hardware separately – Part no. 79018850

Kubota

(Non-Current Production Tractors)

Wheel Weights

Tractor Model	Wheel Size	Hole Pattern	Part No.	Lbs. per Weight	Inside/Outside	Comments
BX22	12"	4 @ 6 1/8"	79018800 **	70	O	
BX1800 - BX2200	12"	4 @ 6 1/8"	79018800 **	70	O	
L35	16" & 19.5" Ind.	None	----	----	----	
	24" Ind.	4 @ 11 1/2"	79018831 (LM8124)	107	I/O	Stacks
B1550 - B2150	16" Ag.	4 @ 7 1/2"	79018826	66	O	Stacks
		4 @ 8 1/2"	79018826	66	O	Stacks
B1700 - B7300	16" Ag.	4 @ 7 1/2"	79018826	66	O	Stacks
		4 @ 8 1/2"	79018826	66	O	Stacks
B4200 - B9200	16" Ag.	4 @ 7 1/2"	79018826	66	O	Stacks
		4 @ 8 1/2"	79018826	66	O	Stacks
B7400 - B7600	16" Ag.	4 @ 7 1/2"	79018826	66	O	Stacks
	16.5" Ind.	4 @ 7 1/2"	79018826 (B8056)	66	O	Stacks
L2350 - L3650	24"	3 @ 8 7/8"	79018783 (L8066)	59	O	Stacks - 3 pr. max
L2500 - L4200	16" Front	4 @ 7 1/2"	79018840	45	I	2 wd - 4 pc. Set
			79018826	66	O	Stacks
	24" Ag. & Ind.	3 @ 8 7/8"	79018783 (L8066)	59	O	Stacks - 3 pr. max
L2600, L3000 & L4300	16" Front	4 @ 7 1/2"	79018840	45	I	2 wd - 4 pc. Set
			79018826	66	O	Stacks
	24" Ag. & Ind.	3 @ 8 7/8"	79018783 (L8066)	59	O	Stacks - 3 pr. max
L3010 - L4610	16" Front	4 @ 7 1/2"	79018840	45	I	2 wd - 4 pc. Set
			79018826	66	O	Stacks
	24" Ag. & Ind.	3 @ 8 7/8"	79018783 (L8066)	59	O	Stacks - 3 pr. max
L4350 - L5450	16" Front	4 @ 7 1/2"	79018840	45	I	2 wd - 4 pc. Set
			79018826	66	O	Stacks
	24" & 26"	4 @ 11 1/2"	79018831 (LM8124)	107	I/O	Stacks
			79018838	146	I/O	Stacks
28" & 30"	4 @ 11 1/2"	79018831 (LM8124)	107	I/O	Stacks	
		79018838	146	I/O	Stacks	
M4030 - M8030	16" Front	4 @ 7 1/2"	79018840	45	I	2 wd - 4 pc. Set
			79018826	66	O	Stacks
	24" & 26"	4 @ 11 1/2"	79018831 (LM8124)	107	I/O	Stacks
			79018838	146	I/O	Stacks
28" & 30"	4 @ 11 1/2"	79018831 (LM8124)	107	I/O	Stacks	
		79018838	146	I/O	Stacks	
M4700 & M5400	16" Front	4 @ 7 1/2"	79018840	45	I	2 wd - 4 pc. Set
			79018826	66	O	Stacks
	24" & 26"	4 @ 11 1/2"	79018831 (LM8124)	107	I/O	Stacks
			79018838	146	I/O	Stacks
28" & 30"	4 @ 11 1/2"	79018831 (LM8124)	107	I/O	Stacks	
		79018838	146	I/O	Stacks	
M4950 - M8950	16" Front	4 @ 7 1/2"	79018840	45	I	2 wd - 4 pc. Set
			79018826	66	O	Stacks
	28" - 34" Steel	4 @ 11 1/2"	79018831 (LM8124)	107	I/O	Stacks
			79018838	146	I/O	Stacks
34" - 38 Cast	4 @ 12 3/4"	79018834	125	I/O	Stacks	
		79018839	148	I/O	Stacks	
M7580 - M9580	16" Front	4 @ 7 1/2"	79018840	45	I	2 wd - 4 pc. Set
			79018826	66	O	Stacks
	28" - 34" Steel	4 @ 11 1/2"	79018831 (LM8124)	107	I/O	Stacks
			79018838	146	I/O	Stacks
34" - 38 Cast	4 @ 12 3/4"	79018834	125	I/O	Stacks	
		79018839	148	I/O	Stacks	

** Order attaching hardware separately – Part no. 79018851

Mahindra

(Current Production Tractors)

Front End Weights and Brackets

Tractor Model	Bracket No.	Lbs. Each	Weight No.	Lbs. Each	Max. Wts. / Bkt.
4500 - 6500					
3510 - 4110	Standard Equip.	----			
2015 - 3215	Standard Equip.	----	79018781	41	
			79018782	70	
5520 - 7520					
3325 - 3525					
4530					
4510 & 7010	Standard Equip.	----	79018803	81	7
			79018804	102	7

Wheel Weights

Tractor Model	Wheel Size	Hole Pattern	Part No.	Lbs. per Weight	Inside/Outside	Comments
4500, 5500, 6000 & 6500 2 & 4 WD	28" & 30" Ag.	3 @ 16 1/2"	79018835	115	I/O	Stacks
	24" Ind.	4 @ 9 1/2"	79018831	107	I/O	Stacks
		None	----	----	----	
3510 - 4110	24" Ag.	3 @ 9 1/2"	79023243	80	I/O	Stacks
	16.5" - 20" Ind.	None	----	----	----	
	24" Ind.	None	----	----	----	
		4 @ 9 1/2"	79018831	107	I/O	Stacks
15" - 24" Turf	None	----	----	----		
2015 - 3215	16" Ag.					
	24" Ag.					
	16.5" Ind.	None	----	----	----	
	19.5" Ind.	None	----	----	----	
	16" Turf	4 @ 7 1/2"	79018826	66	O	Stacks
	16.5" Turf	4 @ 7 1/2"	79018826	66	O	Stacks
	20" Turf	None	----	----	----	
5520, 6520 & 7520	28" & 30" Ag.	3 @ 12 3/4"	79018837	300	I/O	Stacks
	24" Ind.	3 @ 13 1/2"	None	----	----	
3325 & 3525	28" Ag.		Weights are standard equipment			
	24" Ind.		Weights are standard equipment			
4530	28" Ag.		Weights are standard equipment			
	24" Ind.		Weights are standard equipment			
4510 & 7010	24" Ag.					
	30" Ag.	4 @ 11 1/4"	79018831	107	I/O	Stacks
				79018838	146	I/O
	24" Ind.	None	----	----	----	

Mahindra

(Non-Current Production Tractors)

Front End Weights and Brackets

Tractor Model	Bracket No.	Lbs. Each	Weight No.	Lbs. Each	Max. Wts. / Bkt.
2310					
3225					

Wheel Weights

Tractor Model	Wheel Size	Hole Pattern	Part No.	Lbs. per Weight	Inside/Outside	Comments
C27 & C35	24" Ag.	3 @ 91/2"	79023243	80	I/O	Ag. Tire
	18" & 20" Ind.	None	----	----	----	Ind. Tire
	15" & 16" Turf	None	----	----	----	Turf Tire
2310						
3325						
3505-DI	28" Ag.	3 @ 16 1/2"	79018835	115	I/O	Ag. Tire
E350-DI	28" Ag.	3 @ 16 1/2"	79018835	115	I/O	Ag. Tire

Massey Ferguson

(Current Production Tractors)

Front End Weights and Brackets

Tractor Model	Bracket No.	Lbs. Each	Weight No.	Lbs. Each	Max. Wts. / Bkt.
GC2300	79026657	24	79018781	41	6
			79018782	70	6
GC2310TLB	N/A	----	N/A	----	----
1523 – 1560	79023233	25	79018781	41	6
			79018782	70	6
533 – 596	Standard Equip.	----	79018802*	96	10
3425S & 3435S	Standard Equip.	----	79018802*	96	10
3425V & 3435V	Standard Equip.	----	79018802*	96	10
3425GE - 3455GE	Standard Equip.	----	79018802*	96	10
3625 – 3645	Standard Equip.	----	79018802*	96	10
5435 – 5470	Standard Equip.	----	79018802*	96	10
5460SA - 6475SA	Standard Equip.	----	79018802*	96	10
6465 – 6495	Standard Equip.	----	79018801*	79	12
			79018802*	96	10
7465 – 7495	Standard Equip.	----	79018801*	79	12
			79018802*	96	10
8450 – 8480	Standard Equip.	----	79018801*	79	12
			79018802*	96	10

* Order attaching hardware separately – Part no. 79018850

Wheel Weights

Tractor Model	Wheel Size	Hole Pattern	Part No.	Lbs. per Weight	Inside/ Outside	Comments
GC2300	12"	4 @ 6 1/8"	79018800**	70	O	
GC2310TLB	12"	4 @ 6 1/8"	79018800**	70	O	
1523 - 1552	12" Turf	4 @ 6 1/8"	79018800**	70	O	
	15" Turf	None	----	----	----	
	16.5" Turf	4 @ 6 1/8"	79018800**	70	O	
	20" Turf	3 @ 11 3/4"	79018829	75	O	Stacks
	12" & 16" Ag.	4 @ 6 1/8"	79018800**	70	O	
	18" Ag.	4 @ 7 1/2"	79018826	66	I/O	Stacks
	24" Ag.	4 @ 9 1/2"	79018831	107	I/O	Stacks
		4 @ 11 1/2"	79018831	107	I/O	Stacks
	26" Ag.	4 @ 9 1/2"	79018831	107	I/O	Stacks
	28" Ag.	4 @ 11 1/2"	79018831	107	I/O	Stacks
				79018838	146	O
	16.5" Ind.	4 @ 6 1/8"	79018800**	70	O	
	18" Ind.	4 @ 7 1/2"	79018826	66	I/O	Stacks
	19.5" Ind.	None	N/A	----	----	
24" Ind.	4 @ 9 1/2"	79018831	107	I/O	Stacks	

** Order attaching hardware separately – part no. 79018851. Order 1 per weight.

Massey Ferguson

(Current Production Tractors)

Wheel Weights - Continued

Tractor Model	Wheel Size	Hole Pattern	Part No.	Lbs. per Weight	Inside/Outside	Comments
533 - 596	24" Ag	4 @ 8 1/2"	None	----	----	
		4 @ 11"	None	----	----	
	24" Ind.	4 @ 8 1/2"	None	----	----	
	26" Ag.	4 @ 8 1/2"	None	----	----	
	28"	4 @ 11"	79018831	107	I/O	Stacks
			79018838	146	O	Stacks
		4 @ 12 1/2"	None	----	----	
		4 @ 12 7/8"	79018834	125	I/O	Stacks
	30"	4 @ 11"	79018831	107	I/O	Stacks
			79018838	146	O	Stacks
		4 @ 12 7/8"	79018834	125	I/O	Stacks
	34"	4 @ 12 7/8"	79018834	125	I/O	Stacks
	38"	4 @ 11"	79018831	107	I/O	Stacks
79018838			146	O	Stacks	
3425 - 3455 "S, F, V & GE"	20"					
	24"	4 @ 10 3/4"	None	----	----	
	28"					
3625 - 3645	30"	None	79018831	107	I/O	Stacks – Holes must be drilled
			79018838	146	I/O	Stacks – Holes must be drilled
	4 @ 11"	79018831	107	I/O	Stacks	
		79018838	146	I/O	Stacks	
5435 - 5470	30" - 38"	3 @ 14"	79018833	108	I/O	Stacks
5460SA - 5475SA	26"					
	30"					
6465 - 6495	34" - 50" Steel	3 @ 14"	79018833	108	I/O	Stacks – Flange axle - man. Adj.
		4 @ 12 3/4"	79018834	125	O	Stacks – Flange axle - fixed
		None	----	----	----	
	38" - 50" Cast	4 @ 12 3/4"	79018839	148	O	Stacks
		3 @ 17 1/2"	N/A	----	I	
7465 - 7495	34" - 50" Steel	3 @ 14"	79018833	108	I/O	Stacks – Flange axle - man. Adj.
		4 @ 12 3/4"	79018834	125	O	Stacks – Flange axle - fixed
		None	----	----	----	
	38" - 50" Cast	4 @ 12 3/4"	79018839	148	O	Stacks
		3 @ 17 1/2"	N/A	----	I	
8450 - 8480	38" - 54" Steel	4 @ 12 3/4"	79018834	125	O	Stacks
		None	----	----	----	
	38" - 54" Cast	4 @ 12 3/4"	79018839	148	O	Stacks
		3 @ 17 1/2"	N/A	----	I	

Massey Ferguson

(Non-Current Production Tractors)

Front End Weights and Brackets

Tractor Model	Bracket No.	Lbs. Each	Weight No.	Lbs. Each	Max. Wts. / Bkt.
GC2310	Standard Equip.	----	N/A	----	----
1125	Standard Equip.	----	79018781	41	4 – 5
1160 – 1190			79018782	70	4 – 5
1205 – 1260	Standard Equip.	----	79018781	41	4 – 5
			79018782	70	4 – 5
1428V - 1455V	Use Factory Bkt.	----	79018781	41	5
			79018782	70	5
1417 – 1455	Standard Equip.	----	79018781	41	5
			79018782	70	5
240	Standard Equip.	----	79018801*	79	10
231 - 281, 231S			79018802*	96	10
243 – 283					
360 – 399	Standard Equip.	----	79018801*	79	10
			79018802*	96	10
431 – 496	Standard Equip.	----	79018802*	96	10
471 - 796 LP					
3120 – 3680	Standard Equip.	----	79018801*	79	10
			79018802*	96	10
3315S & 3330S	Standard Equip.	----	79018802*	96	7
3340F - 3355F	Standard Equip.	----	79018802*	96	7
3315GE - 3355GE	Standard Equip.	----	79018802*	96	7
3315V - 3340V	Standard Equip.	----	79018802*	96	7
4225 – 4270	Standard Equip.	----	79018802*	96	10
4325 – 4370	Standard Equip.	----	79018802*	96	10
6150 – 6180	Standard Equip.	----	79018801*	79	10
			79018802*	96	10
6255 – 6290	Standard Equip.	----	79018801*	79	10
			79018802*	96	10
8120 - 8160	Standard Equip.	----	79018801*	79	12
			79018802*	96	12
8220 – 8280	Standard Equip.	----	79018801*	79	12
			79018802*	96	12

* Order attaching hardware separately – Part no. 79018850

Massey Ferguson

(Non-Current Production Tractors)

Wheel Weights

Tractor Model	Wheel Size	Hole Pattern	Part No.	Lbs. per Weight	Inside/Outside	Comments
L & G Tractors	12"	4 @ 6 1/8"	79018800**	70	O	
1125 1160 -1190	16" Front	4 @ 7 1/2"	79018840	45	I	2 wd. - 4 pc. Set
			79018826	66	O	Stacks
	20"	4 @ 9 1/2"	79018829	75	O	Stacks
		None	----	----	----	
	24" Ag.	4 @ 9 1/4"	79018829	75	O	Stacks
	24" Ind.	None	----	----	----	
	28"	4 @ 9 1/4"	79018829	75	O	Stacks
3 @ 12 3/4"		79018837	300	I/O	Stacks	
1205 -1260	16" Front	4 @ 7 1/2"	79018840	45	I	2 wd. - 4 pc. Set
			79018826	66	O	Stacks
	20"	4 @ 9 1/2"	79018829	75	O	Stacks
		None	----	----	----	
	24"	4 @ 9 1/4"	79018829	75	O	Stacks
	28"	4 @ 9 1/4"	79018829	75	O	Stacks
		3 @ 12 3/4"	79018837	300	I/O	Stacks
1417 -1455 1428V -1455V	16" Front	4 @ 7 1/2"	79018840	45	I	2 wd. - 4 pc. Set
			79018826	66	O	Stacks
	15" & 16" Turf	None	----	----	----	
	16" Ag.	3 @ 9 1/4"	N/A	----	----	
	16.5" - 24" Ind.	None	----	----	----	
	20" Turf	4 @ 9 1/4"	79018829	75	I/O	Stacks
24" & 28" Ag.	4 @ 9 1/4"	79018829	75	I/O	Stacks	
240 231 -281, 231S 243 -283	16" & 20"	None	----	----	----	
	24"	4 @ 8 1/2"	79018828	170	O	Stacks
		None	79018831	107	O	Hole must be drilled
	28" - 34" Steel	None	79018835	115	O	Hole must be drilled
		3 @ 12 3/4"	79018843***	150	O	Stacks
			79018837	300	I/O	Stacks
	28" Cast	4 @ 12 3/4"	79018834	125	O	Stacks
		3 @ 10 3/4"	79018829	75	O	Stacks
	4 @ 12 3/4"	79018839	148	O	Stacks	
		30" - 38" Cast	4 @ 12 3/4"	79018839	148	O
360 -399	24"	4 @ 8 1/2"	79018828	170	O	Stacks
		None	79018831	107	O	Hole must be drilled
	28" Steel	None	79018835	115	O	Hole must be drilled
	28" - 34" Steel	3 @ 12 3/4"	79018843***	150	O	Stacks
			79018837	300	I/O	Stacks
	28" Cast	3 @ 10 3/4"	79018829	75	O	Stacks
		4 @ 12 3/4"	79018839	148	O	Stacks
	30" - 38" Cast	4 @ 12 3/4"	79018839	148	O	Stacks

** Order attaching hardware separately – Part no. 79018851

*** Will mount inside or outside on 34" – 42" wheels.

Massey Ferguson

(Current Production Tractors)

Wheel Weights

Tractor Model	Wheel Size	Hole Pattern	Part No.	Lbs. per Weight	Inside/Outside	Comments	
431 - 492, 471 - 492 Low Profile	24" Ag	4 @ 8 1/2"	None	----	----		
		4 @ 11"	None	----	----		
	24" Ind.	4 @ 8 1/2"	None	----	----		
	26" Ag.	4 @ 8 1/2"	None	----	----		
	28"	4 @ 11"	79018831	107	I/O	Stacks	
			79018838	146	O	Stacks	
			4 @ 12 1/2"	None	----	----	
	30"	4 @ 12 7/8"	79018834	125	I/O	Stacks	
			4 @ 11"	79018831	107	I/O	Stacks
			79018838	146	O	Stacks	
	34"	4 @ 12 7/8"	79018834	125	I/O	Stacks	
			79018834	125	I/O	Stacks	
38"	4 @ 11"	79018831	107	I/O	Stacks		
		79018838	146	O	Stacks		
3120 - 3680	38" - 42" Cast	4 @ 12 3/4"	79018839	148	O	Stacks	
3315S - 3355F	20" Turf	4 @ 9 1/4"	79018829	75	I/O	Stacks	
3315GE - 3355GE 3315V - 3340V	24" & 28" Ag.	4 @ 9 1/4"	79018829	75	I/O	Stacks	
4225 - 4270	16" & 20" Steel	----	N/A	----	----		
	24" & 26" Steel or Cast	4 @ 8 1/2"	79018828	170	O		
	28" - 38" Steel	3 @ 12 3/4"	79018843	147	O**	Stacks	
			79018837	289	I/O	Stacks	
	28" Cast	3 @ 10 3/4" 4 @ 12 3/4"	79018829	64	O	Stacks	
			79018839	150	O	Stacks	
30" - 38" Cast	4 @ 12 3/4"	79018839	150	O	Stacks		
4325 - 4370	28" - 38"	3 @ 14"	79018833	108	I/O	Stacks	
6150 - 6180	28" - 42"	3 @ 12 3/4"	79018843***	150	O	Stacks	
			79018837	300	I/O	Stacks	
		3 @ 14"	79018833	108	I/O	Stacks	
	28" Cast	3 @ 10 3/4" 4 @ 12 3/4"	79018829	75	O	Stacks	
			79018839	148	O	Stacks	
	30" - 42" Cast	4 @ 12 3/4"	79018839	148	O	Stacks	
6255 - 6290	28" - 42" Steel	3 @ 12 3/4"	79018843***	150	O	Stacks	
			79018837	300	I/O	Stacks	
		3 @ 14"	79018833	108	I/O	Stacks	
	28" Cast	3 @ 10 3/4" 4 @ 12 3/4"	79018829	75	O	Stacks	
			79018839	148	O	Stacks	
	30" - 42" Cast	4 @ 12 3/4"	79018839	148	O	Stacks	
8120 - 8160	28" Cast	3 @ 10 3/4" 4 @ 12 3/4"	79018829	75	O	Stacks	
			79018839	148	O	Stacks	
	30" - 42" Cast	4 @ 12 3/4"	79018839	148	O	Stacks	
8220 - 8280	30" - 38" Steel - Flange Axle	3 @ 14"	79018833	108	I/O	Stacks	
	38" - 54" Steel - Bar Axle	None	----	----	----		
	38" Cast	4 @ 12 3/4" 3 @ 17 1/2"	79018839	148	O	Stacks	
			N/A	----	I		

*** Will mount on inside or outside of 34" wheel and larger.

McCormick

(Current Production Tractors)

Front End Weights and Brackets

Tractor Model	Bracket No.	Lbs. Each	Weight No.	Lbs. Each	Max. Wts. / Bkt.
C50 - C100	79018772	50	79018775	100	12
CX75 - CX105	Factory Bracket	----	79023228	100	9
	79018772	50	79018775	100	12
MC80 - MC135	Factory Bracket	----	79023228	100	9
	79018772	50	79018775	100	12
MTX120 - MTX200	Factory Bracket	----	79023228	100	16
	79023240	67	79018775	100	18
XTX185 - XTX215	Factory Bracket	----	79023228	100	16
	79023240	67	79018775	100	18
ZTX230 - ZTX280	Factory Bracket	----	N/A	----	----

Wheel Weights

Tractor Model	Wheel Size	Hole Pattern	Part No.	Lbs. per Weight	Inside/Outside	Comments
C50 - C100	30" & 34"	3 @ 12 3/4"	79018841	115	O *	Stacks
			79018843	150	O *	Stacks
			79018837	300	I/O	Stacks
CX75 - CX105	30 & 34"	3 @ 12 3/4"	79018841	115	O *	Stacks
			79018843	150	O *	Stacks
			79018837	300	I/O	Stacks
MC80 - MC115	34" & 38"	3 @ 14 5/8"	79018788	163	O	Stacks
MC120 & MC135	34" & 38"	3 @ 14 5/8"	79018788	163	O	Stacks
MTX120 - MTX200	38" - 46"	3 @ 14 5/8"	79018788	163	O	Stacks
XTX185 - XTX215	38" - 46"	3 @ 14 5/8"	79018788	163	O	Stacks
ZTX230 - ZTX280	46" & 50"	3 @ 17"	79018835	115	I/O	Stacks

* Will mount inside and outside on 34" wheel.

New Holland

(Current Production Tractors)

Front End Weights and Brackets

Tractor Model	Bracket No.	Lbs. Each	Weight No.	Lbs. Each	Max. Wts. / Bkt.
TZ18DA - TZ25DA	79021963	18	79018812 *	50	5
			79018805 *	100	5
TC30	Standard	-----	79018812 *	50	5
			79018805 *	100	5
TC21DA - TC55DA	Standard	-----	79018812 *	50	2
			79018805 *	100	2
	79021963	18	79018812 *	50	5
			79018805 *	100	5
	79023235	27	Extension for 79021963 bracket – Required when 79021963 is used on super steer models with ag. tires		
TT55 - TT75	Factory Bkt.	-----	79018807	50	10
			79018808	87	10
	79018822	187	79018807	50	10
			79018808	87	10
	79018819	44	79018803 **	81	10
79018804 **			102	10	
TN60A - TN95A	Factory Bkt.	-----	79018809 ***	88	6 / 10
	79018817	40	79018809 ***	88	6
	79018824 (2 wd only)	192	79018809 ***	88	10
TN60DA - TN95DA	Factory Bkt.	-----	79018809 ***	88	6
	79018817	40	79018809 ***	88	6
	79018824 (2 wd only)	192	79018809 ***	88	10
TN60SA - TN75SA	Factory Bkt.	-----	79018809 ***	88	6
	79018820	37	79018809 ***	88	6
TN60VA - TN95VA	Standard Equip.	-----	Standard Equip.	55	6
TN75FA - TN95FA	79018817 (Std. Axle)	40	79018809 ***	88	6
	79018820	37	79018809 ***	88	6
TD75D & TD95D	Factory Bkt.	-----	79018809 ***	88	6 / 10
	79018817	40	79018809 ***	88	6
	79018824 (2 wd only)	192	79018809 ***	88	10
TK90A - TK100A	N/A	-----	N/A	-----	-----
TL80A - TL100A	Factory Bkt.	-----	79018809 ***	88	10
	79026654	44	79018803 **	81	10
			79018804 **	102	10
TB100 - TB120	Factory Bkt.	108	79018807	50	10
			79018808	87	10
	79018822	187	79018807	50	10
			79018808	87	10
	79018819	44	79018804 **	102	10
TS100A - TS135A	Factory Bkt.	200	79021562	99	18
	79018824 (2 wd only)	192	79018809 ***	88	10
	79018823	44	79018804 **	102	10
TM120 - TM190 T7050	Factory Bkt.	200	79021562	99	10 / 22
	79018824	192	79018809 ***	88	10
	79018823	44	79018804 **	102	10
TV145	Factory Bkt.	-----	79018810	70	22
TG215 - TG305	Factory Bkt.	-----	79021562	99	10 / 22
TJ280 - TJ530	Factory Bkt.	-----	N/A	-----	-----

- * Order hardware kit separately – Part no. 79018849
 ** Order hardware kit separately – Part no. 79018850
 *** Order locking pin separately – Part no. 79018848

New Holland

(Current Production Tractors)

Wheel Weights

Tractor Model	Wheel Size	Hole Pattern	Part No.	Lbs. per Weight	Inside/Outside	Comments
TZ18DA - TZ25DA	12"	4 @ 6 1/8"	79018800	70	O	
TC30	16" Turf	None	None	----	----	
	24" Ag.	4 @ 9 1/2"	79018831	107	I/O	Stacks
	19.5" Ind.	3 @ 10 1/2"	79018829	75	O	Stacks
TC21DA - TC55DA	15" & 16" Turf	None	None	----	----	
	20" Turf	3 @ 11 3/4"	79018829	75	O	Stacks
	16" Front – 2wd	4 @ 7 1/2"	79018840	45	I	4 pc. Set - Stacks
			79018826	66	O	Stacks
	16" Ag	3 @ 8 1/8"	79018826	66	O	Stacks
	24" Ag	4 @ 9 1/2"	79018831	107	I/O	Stacks
	28" Ag	4 @ 9 1/2"	79018831	107	I/O	Stacks
	16.5" Ind.	3 @ 8 1/8"	79018826	66	O	Stacks
	19.5" Ind.	3 @ 10 1/2"	79018829	75	O	Stacks
	24" Ind.	4 @ 9 1/2"	79018831	107	I/O	Stacks
TT55 & TT75	28" & 30" Ag	3 @ 12 3/4"	79018841	115	O	Stacks
			79018843	150	O	Stacks
			79018837	300	I/O	Stacks
TN60A - TN95A	24" Ag.	4 @ 9 1/2"	79018831	107	I/O	Stacks
	28" & 30" Ag.	3 @ 14"	79018833	108	I/O	Stacks
	24" Ind.	4 @ 9 1/2"	79018831	107	I/O	Stacks
TN60DA - TN95DA	24" Ag.	4 @ 9 1/2"	79018831	107	I/O	Stacks
	28" & 30" Ag.	3 @ 14"	79018833	108	I/O	Stacks
	24" Ind.	4 @ 9 1/2"	79018831	107	I/O	Stacks
TN60SA - TN75SA	28" & 30" Ag.	3 @ 14"	79018833	108	I/O	Stacks
	24" Ind.	4 @ 9 1/2"	79018831	107	I/O	Stacks
TN60VA - TN95VA	24" Ag.	4 @ 9 1/2"	79018831	107	I/O	Stacks
	28" Ag.	3 @ 14"	79018833	108	I/O	Stacks
TN75FA - TN95FA	24" Ag.	4 @ 9 1/2"	79018831	107	I/O	Stacks
	28" Ag.	3 @ 14"	79018833	108	I/O	Stacks
TD75D & TD95D	24" Ag.	4 @ 9 1/2"	79018831	107	I/O	Stacks
	28" & 30" Ag.	3 @ 14"	79018833	108	I/O	Stacks
	24" Ind.	4 @ 9 1/2"	79018831	107	I/O	Stacks
TK90A - TK100A	N/A	----	None	----	----	
TL80A - TL100A	30" - 38"	3 @ 14"	79018833	108	I/O	Stacks
TB100 - TB120	30" - 38"	3 @ 12 3/4"	79018841	115	O *	Stacks
			79018843	150	O *	Stacks
			79018837	300	I/O	Stacks
TS100A - TS135A	30" - 38" Flange Axle	3 @ 12 3/4"	79018841	115	O *	Stacks
			79018843	150	O *	Stacks
			79018837	300	I/O	Stacks
	28" - 50" Bar Axle	3 @ 14 5/8"	79018788	163	O	Stacks

* Will Mount inside or outside on 34" & 38" wheels.

New Holland

(Current Production Tractors)

Wheel Weights - Continued

Tractor Model	Wheel Size	Hole Pattern	Part No.	Lbs. per Weight	Inside/Outside	Comments
TM120 - TM190	34" - 46" Steel & Cast	3 @ 14 4/8"	79018788	163	I/O	Stacks
			79018789	142	I/O	Stacks
			79018790		I/O	Stacks
			79018846		I/O	Stacks
T7050	34" - 46" Steel & Cast	3 @ 14 4/8"	79018788	163	I/O	Stacks
			79018789	142	I/O	Stacks
			79018790		I/O	Stacks
			79018846		I/O	Stacks
TV145	34" & 38"	3 @ 12 3/4"	79018841	115	I/O	Stacks
			79018843	150	I/O	Stacks
			79018837	300	I/O	Stacks
TG210 - TG305	38" - 46" Steel	3 @ 22 1/2"	79018789	142	I/O	Stacks
			79018790		I/O	Stacks
			79018846		I/O	Stacks
TJ275 - TJ530	38" - 46" Steel	3 @ 22 1/2"	79018789	142	I/O	Stacks
			79018790		I/O	Stacks
			79018846		I/O	Stacks

** Weight ID = 15 1/4" – Check for possible obstruction with lug bolts.

New Holland

(Current Production Tractors)

Skid Steer Loaders

L120 & L125	N/A	N/A	----	----	----
L140 & L150	79018814	31	79018812 *	50	4 – 2 per side
L160, L170 & L175	79018815	32	79018812 *	50	6 – 3 per side
L180 - L190	79026655	42	79018812 *	50	8 – 4 per side
Non-Current					
LS120 & LS125	N/A	N/A	----	----	----
LS140 & LS150	79018814	31	79018812 *	50	4 – 2 per side
LS160 & LS170	79018815	32	79018812 *	50	6 – 3 per side
LS180 & LS190	79018813	42	79018812 *	50	8 – 4 per side
LS180.B - LS190.B	79026655	42	79018812 *	50	8 – 4 per side
L250 & L255	NA	----	NA	----	----
L465 - LX485	79018814	31	79018812 *	50	4 – 2 per side
L565 - LX665	79018815	32	79018812 *	50	6 – 3 per side
L865 - LX985	79018813	42	79018812 *	50	8 – 4 per side
L553 - L785	NA	----	79018816	50	6 – 3 per side

* Order hardware kit separately – Part no. 79018849

New Holland

(Non-Current Production Tractors)
Front End Weights and Brackets

Tractor Model	Bracket No.	Lbs. Each	Weight No.	Lbs. Each	Replaces Allis No.
1110 - 1910	Standard Equip.	----	79018806 ***	32	5
			79018812 ***	50	5
1215, 1715 & 3415	Standard Equip.	----	79018806 ***	32	5
			79018812 ***	50	5
1220 - 2120	Standard Equip.	----	79018806 ***	32	5
			79018812 ***	50	5
1530 - 1925	Standard Equip.	----	79018812 ***	50	2
			79018805 ***	99	2
	79021963	18	79018812 ***	50	5
			79018805 ***	99	5
79023235	27	Extension for 79021963 bracket – Required when 79021963 is used on super steer models			
TC18 - TC45 TC21A - TC55A	Standard Equip.	----	79018812 ***	50	2
			79018805 ***	99	2
	79021963	18	79018812 ***	50	5
			79018805 ***	99	5
79023235	27	Extension for 79021963 bracket – Required when 79021963 is used on super steer models with ag. tires			
TN55 - TN75 TN55D - TN75D	79018817	40	79018809 **	88	6
TN55S - TN75S	79018820	37	79018809 **	88	6
TN60V & TN75V	79023242	74	79018809 **	88	12
TN70F - TN95F 2WD	79018821	27	79018811	55	6
TN70F - TN95F 4WD	79018825	31	79018811	55	6
TK76 & TK85	79023242	74	79018809 **	88	12
TL80 - TL100	Factory Bracket	175	79021562	99	10
		192	79018809 **	88	10
		44	79018803 *	81	10
2310 - 4610 SU 2wd 3600 & 4600 (Swept back axle)	79018818	43	79018803 *	81	7
			79018804 *	102	7
3000 - 5000 4600 (4wd) 6600 - 7700	79018819	44	79018803 *	81	10
			79018804 *	102	10
2810 - 3910 (4wd) 4610 - 8210 TW5 - TW15 8530 & 8630	79018822	187	79018807	50	10
			79018808	87	10
	79018819	44	79018803 *	81	10
			79018804 *	102	10
3010S	79018824	192	79018809 **	88	10
	79018823	44	79018803 *	81	10
			79018804 *	102	10
3230 - 5030	79018822	187	79018807	50	10
			79018808	87	10
	79018819	44	79018803 *	81	10
			79018804 *	102	10

* Order hardware kit separately – Part no. 79018850

** Order locking pin separately – Part no. 79018848

*** Order hardware kit separately – Part no. 79018849

New Holland

(Non-Current Production Tractors)

Front End Weights and Brackets - Continued

Tractor Model	Bracket No.	Lbs. Each	Weight No.	Lbs. Each	Replaces Allis No.
4835 - 7635	79018824	192	79018809 **	88	10
	79018823	44	79018803 *	81	10
			79018804 *	102	10
5610S - 7610S	79018822	187	79018807	50	10
			79018808	87	10
	79018819	44	79018803 *	81	10
			79018804 *	102	10
5640 - 8340	79018822	187	79018807	50	10
			79018808	87	10
	79018819	44	79018803 *	81	10
			79018804 *	102	10
TS90 - TS110	Factory Bracket	175	79021562	99	10
	79018824	192	79018809 **	88	10
	79018823	44	79018803 *	81	10
			79018804 *	102	10
8010 High Clearance	79018822	187	79018807	50	10
			79018808	87	10
8160 - 8560	Factory Bracket	195	79021562	99	10 - 22
	79018824	192	79018809 **	88	10
	79018823	44	79018803 *	81	10
			79018804 *	102	10
8670 - 8970	Factory Bracket	----	79021562	99	10 - 22
8730 & 8830 TW25 & TW35	NA	----	NA	----	
TV140	Factory Bracket	----	79018810	70	22
9182 - 9882	Use Factory Bkt.	----	79018810	70	12 - 39
9184 - 9884	Front Fact. Bkt.	----	79018810	70	39
	Rear Fact. Bkt.	----	79018810	70	33
	Rear Aux. Bkt.	----	79018810	70	12 per side

* Order hardware kit separately – Part no. 79018850

** Order locking pin separately – Part no. 79018848

*** Order hardware kit separately – Part no. 79018849

New Holland

(Non-Current Production Tractors)

Wheel Weights

Tractor Model	Wheel Size	Hole Pattern	Part No.	Lbs. per Weight	Inside/Outside	Comments	
L & G Tractor	12"	4 @ 6 1/8"	79018800	70	O	Hwd. Part no. 79018851	
1110 - 1910 1215 - 3415 1220 - 2120	16" Front	4 @ 7 1/2"	79018840	45	I	2 wd.- 4 pc. Set	
			79018826	66	O	2 or 4 wd	
	16" Rear	4 @ 7 1/2" or 3 @ 8"	79018826	66	O	Ag. Tire - Stacks	
							19.5" Ind.
	24"	4 @ 7 7/8"	79018830	65	O	Stacks	
	26"	3 @ 12 1/4"	79018830	65	O	Stacks	
	28"	4 @ 11 1/2"	79018831	107	O	Stacks	
1530 - 1925	16"	None	----	----	----	----	
	19.5" Ind.	3 @ 10 1/2"	79018829	75	O	Stacks	
	24"	4 @ 11 1/2"	79018831	107	O	Stacks	
TC18 - TC45 TC21A - TC55A	15" & 16" Turf	None	----	----	----		
	20" Turf	3 @ 11 3/4"	79018829	75	O	Stacks	
	16" Ag.	3 @ 8 1/8"	79018826	66	O	Stacks	
	24" Ag.	4 @ 9 1/2" or 4 @ 11 1/2"	79018831	107	I/O	Stacks	
							16.5" Ind.
			4 @ 7 1/2"	79018826	66	O	Stacks
			79018826	101	O	Stacks	
	19.5" Ind.	3 @ 10 1/2"	79018829	75	O	Stacks	
	24" Ind.	4 @ 9 1/2" 3 @ 10 1/2"	79018831	107	I/O	Stacks	
							79018829
TN55 - TN75 TN55D - TN75D TN55S - TN75S	16" Front	4 @ 7 1/2"	79018840	45	I	2 wd.-4 pc. Set	
			79018826	66	O	2 or 4 wd	
	24" Ag.	4 @ 9 1/2"	79018831	107	O	Stacks	
	24" Ind.	4 @ 9 1/4"	79018829	75	O	Stacks	
	28" - 38"	3 @ 14"	79018833	108	O	Stacks	
TN60V & TN75V	16" Front	4 @ 7 1/2"	79018840	45	I	2 wd.-4 pc. Set	
			79018826	66	O	2 or 4 wd	
	24" Ag. & Ind.	4 @ 9 1/2" 4 @ 9 1/4"	79018831	107	O	Stacks	
79018829							75
TN70F - TN95F	16" Front	4 @ 7 1/2"	79018840	45	I	2 wd.-4 pc. Set	
			79018826	66	O	2 or 4 wd	
	24"	4 @ 9 1/4"	79018829	75	O	Stacks	
	28"	3 @ 14"	79018833	108	O	Stacks	
TK76 & TK85	NA	----	----	----	----	TK76 & TK85	
TL80 - TL100	16" Front	4 @ 7 1/2"	79018840	45	I	2 wd.-4 pc. Set	
			79018826	66	O	2 or 4 wd	
	28 - 38"	3 @ 14"	79018833	108	O	Stacks	

New Holland

(Non-Current Production Tractors)
Wheel Weights - Continued

Tractor Model	Wheel Size	Hole Pattern	Part No.	Lbs. per Weight	Inside/Outside	Comments
2810 - 8010 3000 - 5000	16" Front	4 @ 7 1/2"	79018840	45	I	2 wd.- 4 pc. Set
	24" & 26"	3 @ 12 3/4"	79018837	300	Opp. Valve Stem	Stacks
3600 - 7700 TW5 & TW15	28 - 38" Square disc	3 @ 12 3/4"	79018841	115	O *	Stacks
			79018843	150	O *	Stacks
			79018837	300	I/O	Stacks
	34" & 38" Cast	3 @ 19"	79018841	115	O	Stacks
	28" & 30" Round disc	3 @ 16 1/2"	79018835	115	O	Stacks
	24" & 26" Cast MA	3 @ 10 3/4"	79018832	100	O	Stacks
	28" & 30" 5 Rail PA	3 @ 10 3/4"	79018832	100	O	Stacks
	30" & 34" 6 Rail PA	3 @ 12 1/2"	79018829	75	O	Stacks
3230 - 5030	16" Front	4 @ 7 1/2"	79018840	45	I	2 wd.-4 pc. Set
			79018826	66	O	2 or 4 wd
	24"	3 @ 12 3/4"	79018837	300	Opp. Valve Stem	Stacks
	28 - 38" Square disc	3 @ 12 3/4"	79018841	115	O *	Stacks
			79018843	150	O *	Stacks
			79018837	300	I/O	Stacks
4835 - 7635	16" Front	4 @ 7 1/2"	79018840	45	I	2 wd.-4 pc. Set
			79018826	66	O	2 or 4 wd
	28" - 38"	3 @ 14"	79018833	108	O	Stacks
3010S	16" Front	4 @ 7 1/2"	79018840	45	I	2 wd.-4 pc. Set
			79018826	66	O	2 or 4 wd
	28"	3 @ 12 3/4"	79018841	115	O	Stacks
			79018843	150	O	Stacks
			79018837	300	I/O	Stacks
5610 - 7610S	16" Front	4 @ 7 1/2"	79018840	45	I	2 wd.-4 pc. Set
			79018826	66	O	2 or 4 wd
	30" Square disc	3 @ 12 3/4"	79018841	115	O	Stacks
			79018843	150	O	Stacks
			79018837	300	I/O	Stacks
	34" Square disc	3 @ 12 3/4"	79018841	115	I/O	Stacks
			79018843	150	I/O	Stacks
			79018837	300	I/O	Stacks
5640 - 8340	16" Front	4 @ 7 1/2"	79018840	45	I	2 wd.-4 pc. Set
			79018826	66	O	2 or 4 wd
	24" & 26"	3 @ 12 3/4"	79018837	300	Opp. Valve Stem	Stacks
	28 - 38" Square disc	3 @ 12 3/4"	79018841	115	O *	Stacks
			79018843	150	O *	Stacks
			79018837	300	I/O	Stacks
	38" Cast	3 @ 19"	79018841	115	O	Stacks

* Will Mount inside or outside on 34" & 38" wheels.

New Holland

(Non-Current Production Tractors)
Wheel Weights - Continued

Tractor Model	Wheel Size	Hole Pattern	Part No.	Lbs. per Weight	Inside/Outside	Comments
TS90 - TS110	24" & 26" Steel	3 @ 12 3/4"	79018837	300	Opp. Valve Stem	Stacks
	28 - 38" Steel	3 @ 12 3/4"	79018841	115	O *	Stacks
			79018843	150	O *	Stacks
			79018837	300	I/O	Stacks
	30 - 38" Cast	3 @ 12 3/4"	79018841	115	O	Stacks
8010	38"	3 @ 12 3/4"	79018841	115	O	Stacks
			79018843	150	O	Stacks
			79018837	300	I/O	Stacks
8160 - 8560	34" & 38" Flange Axle	3 @ 12 3/4"	79018841	115	O	Stacks
			79018843	150	O	Stacks
			79018837	300	I/O	Stacks
	38" - 46" Bar Axle	3 @ 14 5/8"	79018788	163	O	Stacks
8670 - 8970	38" - 46" Steel	3 @ 18 1/2"	NA	----	----	----
	38 - 46" Cast	3 @ 15 1/2"	79018842	83	I/O	Stacks
8530 & 8830 TW25 - TW35	38" & 42"	3 @ 15 1/2"	79018842	83	I/O	Stacks
			79018847	432	I/O	Stacks
TV140	28 - 38" Steel	3 @ 12 3/4"	79018841	115	O *	Stacks
			79018843	150	O *	Stacks
			79018837	300	I/O	Stacks
9282 - 9882	----	None	----	----	----	----
9184 - 9884	----	None	----	----	----	----
Industrial Tractors	24" & 28" 1 pc. wheel	3 @ 12 3/4"	79018837	300	O	Stacks
	24" & 28" 2 pc. wheel	3 @ 10 3/4"	79018832	100	O	Stacks

* Will Mount inside or outside on 34" & 38" wheels.



Power Guard



Grill Guard – Weight Carrier – Headlight Guard

The Power Guard is heavy duty to provide superior protection to the front of your tractor. The weight carrier holds up to 8 – 100 lb. weights, part no. 79018804 (* Holds 5 of 79018812 – 50 lb. Suitcase weight)

<u>Application</u>	<u>Part No.</u>	<u>Shipping Weight</u>
Case		
385 – 885, 395 – 995 3200 & 4200 series	79026670	120 lbs.
CX50 – CX100, C50 – C100	79026671	120 lbs.
JX55 – JX95	79026672	107 lbs.
MX100 – MX120	79026681	110 lbs.
New Holland		
1215 – 3415, 1320 – 2120, TC30	79026682 *	90 lbs.
1530 – 1925, TC25, TC29 & TC33 (W/O Super steer)	79026683 *	50 lbs.
2830 – 4630	79026684	125 lbs.
5640 – 8340	79026698	125 lbs.
TL70 – TL100, TS90 – TS110	79026699	107 lbs.
TN55 – TN75 (w/o super steer)		
5610S – 7610S (Not 3010S) & 100 Series (ex. 5900)	79026700	125 lbs.
345D, 445D & 555D	79026701	101 lbs.
John Deere		
5200 – 5500, 5210 & 5310 5220 & 5320 (w/o front loader)	79026702	100 lbs.
5200 – 5500, 5210 & 5310 5220 & 5320 (w/ front loader)	79026703	100 lbs.
5410 & 5510, 5420 & 5520	79026704	100 lbs.
Kubota		
M4030 – M6030, M4700 & M5400 7040 - 9540	79026711	120 lbs.
M4900 & M5700, M6800 – M9000	79026712	100 lbs.
L2250 – L3250, L2600 – L4200 L3010 – L4610, L3130 – L5030	79026713	110 lbs.
Long		
360, 2460, 2510, 560, 610, 480, 520 680, 2360	79026714	120 lbs.
Farm Trac 45 – 80	79026715	125 lbs.
Massey Ferguson		
230 – 253 (2wd only)	79026716	125 lbs.
271 – 281 (2wd only)	79026722	115 lbs.
362 – 399	79026723	100 lbs.
431	79026724	115 lbs.
4225 – 4270, 4325 – 4370	79026725	120 lbs.

FLUID GUIDE

CAST IRON WHEEL WEIGHTS









VS.

FILLING TIRES WITH FLUID

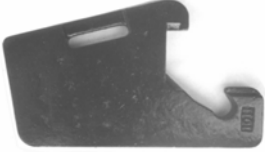







REASONS WHY CAST IRON WHEEL WEIGHTS SHOULD BE USED INSTEAD OF LIQUID BALLAST:

- ✓ Most wheel, tire & tractor manufacturers, including **Michelin, Goodyear, Firestone & Titan**, recommend cast iron for ballast weight.
- ✓ Less damage to power train & steering system.
- ✓ Power hop tendency is significantly decreased.
- ✓ Tires are less difficult to service & repair.
- ✓ Ride comfort is increased due to increased air cushion.
- ✓ Tires are less vulnerable to impact & damage.

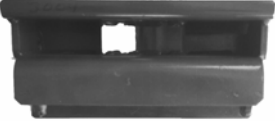
<p>79018766</p>		<p>62 Lbs. each</p> <p>Thickness: 1 ½"</p> <p>Replaces White & Allis No. 76710290</p>
<p>79018767</p>		<p>87 Lbs. each</p> <p>Thickness: 1 ½"</p> <p>Replaces White & Allis No. 76710300</p>
<p>79018765</p>		<p>98 Lbs. each</p> <p>Thickness: 2 5/16"</p> <p>Replaces White & Allis No. 70264161</p>
<p>79023005</p>		<p>123 Lbs. each</p> <p>Thickness: 1 3/8"</p> <p>Used on Agco & Challenger factory bracket</p>
<p>79024963</p>		<p>102 Lbs. each</p> <p>Thickness:</p> <p>Used on Challenger factory bracket</p>
<p>79018844</p>		<p>113 Lbs. each</p> <p>OD: 25" ID: 13"</p> <p>Thickness: 1 ½"</p> <p>3 @ 18 7/8"</p>

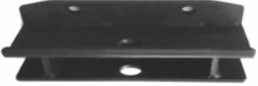

<p>79018768</p>		<p>165 Lbs. each</p> <p>OD: 26" ID: 11 3/4" Thickness: 4"</p> <p>4 @ 14 1/4"</p>
<p>79018772</p>		<p>50 Lbs. each</p> <p>Holds 12 of #79018775</p> <p>Used on Case tractors</p>
<p>79023240</p>		<p>67 Lbs. each</p> <p>Holds 18 of 79018775</p> <p>Used on Case 7200 & 8900 Series</p>
<p>79026654</p>		<p>44 Lbs. each</p> <p>Holds 10 of #79018803, 79018804</p> <p>Used on New Holland, Case & Agco</p>
<p>79018774</p>		<p>53 Lbs. each</p> <p>Holds 9 of #79018794</p> <p>Used on Case tractors</p>
<p>79023241</p>		<p>Lbs. each</p> <p>Holds 10 of 79018794 or 14 of 79018803,</p> <p>Used on Case tractors</p>







<p>79018775</p>		<p>100 Lbs. each</p> <p>Thickness: 1 5/16"</p> <p>Used on #79018772 & #79018773</p> <p>Factory duplicate</p>
<p>79023228</p>		<p>100 Lbs. each</p> <p>Thickness: 2 1/8"</p> <p>Used on Case & McCormick factory bracket</p>
<p>79018836</p>		<p>500 Lbs. each</p> <p>OD: 21" ID: 11 5/8"</p> <p>Thickness: 9 3/8"</p> <p>4 @ 9 1/2" – 11 1/2"</p>
<p>79018776</p>		<p>150 Lbs. each</p> <p>Case Uni-loader frame weight</p> <p>Mounts on 1818 – 1845C in place of fact.</p>
<p>79018817</p>		<p>40 Lbs. each</p> <p>Holds 6 of #79018809</p> <p>Used on New Holland</p> <p>Order pin #79018848 if needed</p>
<p>79018818</p>		<p>42 Lbs. Each</p> <p>Hold 7 of #79018803 or #79018804</p> <p>Used on New Holland</p>







79018819		44 Lbs. each Holds 10 of #79018803 or #79018804 Used on New Holland
79018820		37 Lbs. each Holds 6 of 79018809 Used on New Holland Order pin #79018848 if needed
79023242		74 Lbs. each Holds 12 of 79018809 Used on New Holland TN65V & TN75V Order pin #79018848 if needed
79018821		27 Lbs. each Holds 6 of 79018811 Used on New Holland
79018822		187 Lbs. each Holds 10 of #79018807 or #79018808 Used on New Holland
79018823		44 Lbs. each Holds 10 of #79018803 or #79018804 Used on New Holland
79018824		185 Lbs. each Holds 10 of 79018809 Used on New Holland Order pin #79018848 if needed





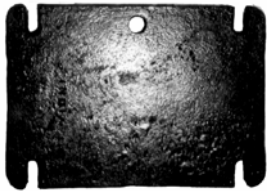

<p>79018825</p>		<p>31 Lbs. each</p> <p>Holds 6 of 79018811</p> <p>Used on New Holland</p>
<p>79021963</p>		<p>18 Lbs. each</p> <p>Holds 5 of 79018812 or 79018805</p> <p>Front bracket for NH TC18 – TC45 & Case models D25 – DX5. If used with supersteer axle, 79023235 Bracket extension is required.</p>
<p>79023235</p>		<p>27 Lbs. each</p> <p>Bracket extension for 79021963. Required when 79021963 is Used on NH TC18 – TC45 With supersteer axle.</p>
<p>79018806</p>		<p>32 Lbs. each</p> <p>Thickness: 3 1/8"</p> <p>Order hardware separately - Part no. 79018849</p>
<p>79018807</p>		<p>50 Lbs. each</p> <p>Thickness: 1 5/8"</p> <p>Used on #79018822 and NH factory bkt.</p>





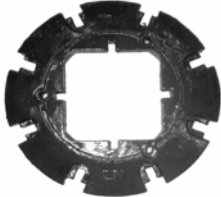

<p>79018803</p>		<p>81 Lbs. each</p> <p>Thickness: 2" Used on #3002, #79018819 & #79018823</p> <p>Order hardware separately - Part no. 79018850</p>
<p>79018808</p>		<p>87 Lbs. each</p> <p>Thickness: 1 ½"</p> <p>Used on #79018822 and NH factory bkt.</p>
<p>79018804</p>		<p>99 Lbs. each</p> <p>Thickness: 2" Used on #3002, #79018819 & #79018823</p> <p>Order hardware separately - Part no. 79018850</p>
<p>79018809</p>		<p>88 Lbs. each</p> <p>Thickness: 2 ¼"</p> <p>Used on #79018824, 3001, #79018820 & Fact. Bkt.</p> <p>Order pin #79018848 separately if needed.</p>
<p>79018810</p>		<p>70 Lbs. each</p> <p>Thickness: 1"</p> <p>Used on New Holland</p>





<p>79018811</p>		<p>55 Lbs. each</p> <p>Thickness: 2 ¼"</p> <p>Used on #79018821, #79018825 & Factory Bkt.</p>
<p>79018805</p>		<p>99 Lbs. each</p> <p>Thickness: 3 ¼"</p> <p>Used on NH Boomer Series & #79021963</p> <p>Also used on Case compact tractors</p>
<p>79021562</p>		<p>99 Lbs. each</p> <p>Thickness: ¾" – 1 ¼" (tapered weight)</p> <p>Used on NH factory bracket found on TL, TS & Series tractors</p>
<p>79018830</p>		<p>65 Lbs. each</p> <p>OD: 17 7/8" ID: 9 7/8"</p> <p>Thickness: 2 3/8"</p> <p>4 @ 7 7/8"</p> <p>3 @ 12 3/16"</p>
<p>79018842</p>		<p>83 Lbs. each</p> <p>OD: 22 13/16"</p> <p>ID: 15 13/16"</p> <p>Thickness: 1 5/8"</p> <p>3 @ 15 ½"</p>
<p>79018832</p>		<p>100 Lbs. each</p> <p>OD: 18 3/8" ID: 10 1/8"</p> <p>Thickness: 2 3/8"</p> <p>3 @ 10 ¾"</p>







79018841		115 Lbs. each OD: 23 13/16" ID: 11 1/4" Thickness: 2 3/4" 3 @ 12 3/4" 3 @ 18 7/8"
79018833		108 Lbs. each OD: 19 3/4" ID: 10 1/4" Thickness: 2 11/16" 3 @ 14"
79018847		432 Lbs. each OD: 28" ID: 16 3/8" Thickness: 5 1/2" 3 @ 15 1/2"
79018814		31 Lbs. each Hold 4 of #79018812 (2 per side) Used on LS140 & LS150, L265 & LX485
79018815		32 Lbs. each Holds 6 of #79018812 (3 per side) Used on L160 – L175, LS160 & LS170, L565 – LX665 New Holland Skid Steers
79018813		42 Lbs. each Holds 8 of #79018812 (4 per side) Used on LS180 & LS190, L865 – LX995 New Holland Skid Steers





<p>79026655</p>		<p>50 Lbs. each</p> <p>Holds 8 of #79018812 (4 per side)</p> <p>Used on LS180.B - LS190.B, L180 – L190 New Holland Skid Steers</p>
<p>79018812</p>		<p>50 Lbs. each</p> <p>Thickness: 3"</p> <p>Used on NH compacts & Skid Steer Loaders</p> <p>Order hardware separately - Part no. 79018849</p>
<p>79018816</p>		<p>49 Lbs. Each</p> <p>Used on NH Skid Steers Models L553 – L785</p>
<p>79018829</p>		<p>75 Lbs. each</p> <p>OD: 17 ½" ID: 10 1/8" Thickness: 2 ¾"</p> <p>3 @ 9 7/8" – 12 ½" 4 @ 9 ¼" – 10 ¼"</p>
<p>79018826</p>		<p>66 Lbs. each</p> <p>OD: 14 7/8" ID: 7 ¾" Thickness: 3 ½"</p> <p>3 @ 8 1/8" 4 @ 7 ¼" – 8 ½"</p>
<p>79018827</p>		<p>95 Lbs. each</p> <p>OD: 16 ¾" ID: 7 ¾" Thickness: 3 ½"</p> <p>3 @ 8 1/8" 4 @ 7 ¼" – 8 ½"</p>

<p>79018831</p>		<p>107 Lbs. each</p> <p>OD: 18" ID: 9 3/4" Thickness: 2 1/2"</p> <p>4 @ 9 1/2", 11" & 11 1/2"</p>
<p>79018835</p>		<p>115 Lbs. each</p> <p>OD: 20 1/4" ID: 11 1/2" Thickness: 2 3/8"</p> <p>3 @ 16 1/2"</p>
<p>79018843</p>		<p>150 Lbs. each</p> <p>OD: 23" ID: 10 1/2" Thickness: 2"</p> <p>3 @ 12 3/4" 4 @ 8 1/2"</p>
<p>79018837</p>		<p>300 Lbs. each</p> <p>OD: 21 1/2" ID: 10 1/2" Thickness: 5 1/4"</p> <p>3 @ 12 3/4" 4 @ 8 1/2"</p>
<p>79023243</p>		<p>80 Lbs. each</p> <p>OD: 17 1/2" ID: 8 1/2" Thickness: 2 7/8"</p> <p>3 @ 9 1/4" - 12 1/2" 4 @ 9 1/4" - 10 1/4"</p>
<p>79018848</p>		<p>Attaching hardware for #79018809 when used with #3001, #79018820 & factory brackets</p>





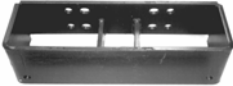

<p>79018849</p>		<p>Attaching hardware for #79018806, #79018812 & #79018805 when used on NH compact tractors.</p> <p>One bolt kit needed per weight</p>
<p>79018850</p>		<p>Attaching hardware for #79018803 & #79018804 when used with #79018819 & #79018823 brackets.</p> <p>One bolt kit needed per weight except when used With 2011 (use 1 bolt kit per 2 weights)</p>
<p>79018787</p>		<p>111 Lbs. each</p> <p>Hold 8 of #79018792 or 10 of #79021563</p> <p>Used on John Deere Utility tractors</p>
<p>79018784</p>		<p>123 Lbs. each</p> <p>Hold 10 of #79018792 or 14 of #79021563</p> <p>Used on John Deere</p>
<p>79018785</p>		<p>44 Lbs. each</p> <p>Holds 8 of #79018781</p> <p>Used on John Deere 240 & 250 skid steers</p>
<p>79018786</p>		<p>48 Lbs. each</p> <p>Holds 8 of #79018781</p> <p>Used on John Deere 260 & 270 skid steers</p>





<p>79021938</p>		<p>281 Lbs. each</p> <p>Holds 10 of 79018792 or 14 of 79021563</p> <p>Used on JD 5410, 5410N, 5510, 5510N 5420, 5420N, 5520, 5520N Replaces JD no. AR124753</p>
<p>79023229</p>		<p>161 Lbs. each</p> <p>Holds 14 of 79018792 or 20 of 79021563</p> <p>Used on JD 7000 series and larger</p> <p>Replaces JD no. R82549</p>
<p>79026656</p>	<p>Picture currently not available.</p>	<p>142 Lbs. each</p> <p>Holds 8 of #79018781</p> <p>Used on John Deere 325, 328 & 332 skid steers</p>
<p>79018792</p>		<p>100 Lbs. each</p> <p>Thickness: 2 ½"</p> <p>Used on #79018787, #79018784, #79021938 & #79023229 bkts.</p> <p>Replaces JD no. R51680</p>
<p>79018793</p>		<p>97 Lbs. each</p> <p>Thickness: 1 7/16"</p> <p>Used on #79018787, #79018784, #79021938 & #79023229 bkts.</p> <p>Replaces JD no. R58823</p>
<p>79021563</p>		<p>100 Lbs. each</p> <p>Thickness: 1 7/16"</p> <p>Used on #79018787, #79018784, #79021938 & #79023229 bkts.</p> <p>Replaces JD no. R127764</p>



<p>79018789</p>		<p>142 Lbs. each</p> <p>OD: 27 3/4" ID: 17 1/2" Thickness: 1 5/8"</p> <p>3 @ 22 1/4" – 22 1/2"</p>
<p>79018790</p>		<p>500 Lbs. each</p> <p>OD: 27 3/4" ID: 15 1/4" Thickness: 5 3/8"</p> <p>3 @ 22 1/4" – 22 1/2"</p>
<p>79018845</p>		<p>573 Lbs. each</p> <p>OD: 25 1/4" ID: 11 3/4" Thickness: 6"</p> <p>3 @ 16 1/2"</p>
<p>79018846</p>		<p>700 Lbs. each</p> <p>OD: 27 3/4" ID: 15 1/4" Thickness: 7 7/8"</p> <p>3 @ 22 1/4" – 22 1/2"</p>
<p>79018781</p>		<p>41 Lbs. each</p> <p>Thickness: 2 1/2"</p> <p>Used on compact tractors & JD skid steer loaders</p>
<p>79018782</p>		<p>70 Lbs. each</p> <p>Thickness: 2 1/2"</p> <p>Used on compact tractors</p>





<p>79018800</p>		<p>70 Lbs. each</p> <p>OD: 11 1/2" ID: 3" Thickness: 3 1/4"</p> <p>4 @ 5 1/4" – 6 1/8" Order hardware separately - Part no. 79018851</p>
<p>79018788</p>		<p>163 Lbs. each.</p> <p>OD: 24 1/4" ID: 13 1/4" Thickness: 3 1/4"</p> <p>3 @ 14 5/8"</p>
<p>79018851</p>		<p>Attaching hardware for #79018800</p> <p>Order one bolt kit per weight.</p>
<p>79018798</p>		<p>51 Lbs. each</p> <p>Holds 9 of #79018794 or 10 of #3107 Order wt. attaching hardware, part no. 79018855, separately</p> <p>Used on Kubota "M" series</p>
<p>79018797</p>		<p>22 Lbs. each</p> <p>Holds 5 of #79018795 & #79018796</p> <p>Used on Kubota BX1800 & BX2200</p>
<p>79023231</p>		<p>22 Lbs. each</p> <p>Holds 5 of 79018795 or 79018796</p> <p>Used on Kubota L2600 – L4300 & L3010 – L4610</p>

<p>79023236</p>		<p>27 Lbs. each</p> <p>Holds 7 of 79018795 or 79018796 Used on Kubota L3130 – L5030, MX5000 Replaces Kubota no. MX8068</p>
<p>79023244</p>		<p>142 Lbs. each</p> <p>Holds 12 of 79018799 Order wt. attaching hardware, part no. 79018854, separately. Used on Kubota M-110 & M-120 Replaces Kubota no. M9265</p>
<p>79023245</p>		<p>72 Lbs. each</p> <p>Holds 10 of 79018799 Order wt. attaching hardware, part no. 79018853, separately. Used on Kubota M4800, M4900 & M5700 Replaces Kubota no. M8070</p>
<p>79018795</p>		<p>52 Lbs. each</p> <p>Thickness: 2 1/8" Used on Kubota B & L Replaces Kub. No. BL8060 Order hardware separately - Part no. 79021726</p>
<p>79018796</p>		<p>77 Lbs. each</p> <p>Thickness: 2 1/8" Used on Kubota B & L series Replaces Kub. No. BL8060 Order hardware separately - Part no. 79021726</p>
<p>79018799</p>		<p>102 Lbs. each</p> <p>Thickness: 2 7/16" Used on Kub. Fact. Bkt Replaces Kub. No. M8071 Order hardware separately</p>

79018852		Attaching hardware for #79018799 when used with Kubota bkt. which holds 8 of M8071
79018853		Attaching hardware for #79018799 when used with Kubota bkt. which holds 10 of M8071
79018854		Attaching hardware for #79018799 when used with Kubota bkt. which holds 12 of M8071
79018855		Attaching hardware for #79018794 when used with 79018798 bracket used on Kubota M4900 & M5700, M6800 – M9000
79018783		59 Lbs. each OD: 17 7/8" ID: 8 1/2" Thickness: 1 1/2" 3 @ 8 7/8"
79018794		98 Lbs. each Thickness: 1 7/8" Used on # 2004, #79018798& Case Fact. Bkt. Order hardware separately
79018840		45 Lbs. each (4 pc. Set) OD: 15 1/2" ID: 4 3/4" Thickness: 3 1/4" 4 @ 7 1/2"

<p>79021726</p>		<p>Attaching hardware for #79018795 & #79018796 when used with #79018797, #79023231, #79023236 & Kubota factory brackets</p> <p>One bolt kit needed per weight</p>
<p>79026657</p>	<p>Picture currently not available.</p>	<p>Lbs. each</p> <p>Holds 6 of 79018781 or 79018782</p> <p>Used on Agco ST22A – ST33A, MF GC2300</p>
<p>79018801</p>		<p>79 Lbs. each</p> <p>Thickness: 2"</p> <p>Used on MF fact. Bkts. Order hardware separately - Part no. 79018850</p>
<p>79018802</p>		<p>96 Lbs. each</p> <p>Thickness: 2"</p> <p>Used on MF factory bkts. Order hardware separately - Part no. 79018850</p>
<p>79018839</p>		<p>148 Lbs. each</p> <p>OD: 22 1/2" ID: 11" Thickness: 2"</p> <p>4 @ 12 3/4"</p>
<p>79018828</p>		<p>170 Lbs. each</p> <p>OD: 16 7/8" ID: 8 7/8" Thickness: 4 1/2"</p> <p>4 @ 8 1/2"</p>

<p>79018834</p>		<p>125 Lbs. each</p> <p>OD: 20" ID: 11" Thickness: 2 ½"</p> <p>4 @ 11 3/8" & 12 ¾"</p>
<p>79018838</p>		<p>146 Lbs. each</p> <p>OD: 21 ¼" ID: 11 ½" Thickness: 4"</p> <p>4 @ 9 ½" – 11 ½"</p>
<p>79018778</p>		<p>31 Lbs. each</p> <p>Holds 7 of #79018812</p> <p>Category I - 3 pt. hitch bracket.</p>
<p>79026658</p>		<p>14 Lbs. each</p> <p>Holds 5 of 79018795</p> <p>Used on Kioti DK35 – DK50</p>
<p>79023237</p>		<p>40 Lbs. each</p> <p>Holds 8 of 79018812</p> <p>Used on ASV RC30 – RC100 Skid Steer</p>
<p>79026659</p>		<p>42 Lbs. each</p> <p>Holds 7 of 79018795</p> <p>Used on Kioti DK65</p>
<p>79026660</p>		<p>14 Lbs. each</p> <p>Holds 5 of 79018795</p> <p>Used on Kioti DK55</p>

79026668		15 Lbs. each Holds 5 of 79018795 or 79018796 Used on Kioti LB1914 & LK3054XS
79021942		11 Lbs. each Holds 4 of #79018781 Used on Cub Cadet Replaces Cub no. 190307
79026669		12 Lbs. each Holds 4 of #79018781 Used on Cub Cadet Replaces Cub no. 190413
79023246		12 Lbs. each Holds 6 of 79018781 Used on Cub Cadet 7264 & 7284
79023247		16 Lbs. each Holds 6 of 79018781 Used on Cub Cadet 5234D - 5254
79023233	Picture Not Available	23 Lbs. each Holds 6 of 79018781 Used on Agco, Massey Ferguson & Branson

<p>79018769</p>		<p>19 Lbs. each</p> <p>Bobcat axle weight (includes hardware)</p>
<p>79023230</p>		<p>20 lbs. each</p> <p>Holds 4 of 79018812 (2 per side)</p> <p>Universal skid steer bkt. Mounting hardware included.</p>
<p>79018771</p>		<p>40 Lbs. each</p> <p>Holds 8 of #79018812 (4 per side)</p> <p>Universal skid steer bkt. Mounting hardware included.</p>
<p>79021564</p>		<p>197 Lbs. each</p> <p>Gehl counter weight – Models 4635 & 4835</p> <p>Includes mounting hardware</p>
<p>79021565</p>		<p>344 Lbs. each</p> <p>Gehl counter weight – Models 5635 & 6635</p> <p>Includes mounting hardware</p>
<p>79023232</p>		<p>216 Lbs. each</p> <p>Gehl counter weight – Models 4640 & 4840</p> <p>Includes mounting hardware</p>

79023378



400 Lbs. each

Gehl counter weight – Models 5640 & 6640

Includes mounting hardware

Weights and Tire Chains Reference Guide

